

VARIOBOT[®]
DISCOVER MECHATRONICS

varikabi

+ varikabi FT

A Variable Robot Kit with
12 Astounding Functions

AGE

8+

ASSEMBLY

1h

PARTS

30

FT

59

for
plugging

Instructions



Safety instructions

Before building and using the robot, it is important to read the following precautions. Please follow them!

- **Caution:** The varikabi kit is not a toy and is intended solely for educational, instructional, and experimental purposes. Any liability is excluded when used for other tasks.
- It may only be assembled and operated by children and adolescents under the guidance and supervision of adults.
- Adults must read, the instructions before use, follow them, and keep them on hand. Please retain packaging for future reference.
- Ensure product remains out of the reach of children under the age of 6.
- Do not use in areas where small animals are present.
- For safety reasons, never leave the robot unattended.
- **Caution:** Due to varikabi's open structure, there are sharp edges and corners.
- Since varikabi doesn't have a cover, be extra careful to keep metal objects and tools from causing a short circuit.
- varikabi may only be used indoors. Do not use this robot in traffic areas!
- Do not use varikabi on tables and other surfaces from which it could fall.
- Only use the robot in dry, clean spaces. Dirt, dust, foreign objects, and dampness destroy the mechanics and electronics.
- **Caution:** Do not hook up devices to the robot, especially not ones with mains voltage!

- Although the constructions and circuits introduced in this instruction manual were designed and tested with as much accuracy and detail as possible, errors cannot be entirely excluded.
- This product was produced in accordance with the currently effective European Union directives and, therefore, has the CE symbol.
- The intended use of this kit is described in this instruction manual. If you deviate from the instructions, the guarantee and liability will be forfeited and the use of the robot is at your own risk! Build the circuits exactly as described in the instructions.
- The symbol of the garbage can/rubbish bin with an X through it means that this product may not be put into household garbage bins; it should be brought to a recycling center and added to the electronic scrap. Please take the time to find where you can best recycle your electronic scrap!

Battery Information:

- The kit requires a 9 V battery, which is not included in the package.
- Risk of Explosion: Non-rechargeable batteries may not be charged.
- Avoid short circuiting the battery, since it can cause the cables to overheat and the battery to explode. After use, the battery clip must be removed from the battery.
- Avoid deforming the batteries.
- Used batteries must be disposed of according to environmental regulations. Please take them to a designated collection container.



Introduction

We are pleased you have chosen this versatile robot assembly kit. varikabi offers you an exciting and playful approach to electronics. You will certainly have fun experimenting and tinkering with varikabi for a long time.

varikabi's "eyes" are three brightness sensors and his "brain cells" are two transistors. With the help of a patented combination of sensors, varikabi perceives the smallest contrasts in its environment and reacts to them in multiple ways.

varikabi can do many things:

- skillfully avoid objects
- follow dark or light lines
- follow or push objects
- search for, chase or circle around light
- follow or circle around the shadow of your hand
- avoid dark or light areas

Building an autonomous robot was never easier! The control circuits are placed on a small breadboard, making them easily modifiable. By varying the circuit and adjusting the sensors in different ways, you'll explore twelve amazing functions and behaviors.

Fischertechnik

varikabi is available in red, blue, green, light green, pink, yellow, black, and the Fischertechnik version.



Content

A) Assembly

In this section, the assembly of the eight varikabi models is described step by step and with numerous illustrations.

All seven of the models can be built with any of the seven color variants.

varikabi FT is a separate kit consisting of Fischertechnik building blocks.

- varikabi as a Dog (red) p. 07
- varikabi as a Sea Lion (blue) p. 14
- varikabi as a Frog (green) p. 19
- varikabi as a Bird (light green) p. 24
- varikabi as a Giraffe (yellow) p. 29
- varikabi as a Mouse (pink) p. 36
- varikabi as a Beetle (black) p. 43
- varikabi FT (Fischertechnik) p. 50

B) Circuit

Starting on page 54, the construction of the circuit is explained. And if something doesn't work as expected, you'll also find an error diagnosis here.

C) Circuit variants

As of page 60, you will learn how to modify the control circuit to set up twelve amazing functions with four basic behaviors.

D) How it works

Starting on page 69, the individual components and control circuits are described in more detail. You will learn how varikabi's behaviors are generated.

E) Expansion sets

Three exciting expansion sets (beginning on page 75) ensure even longer-lasting experimentation and fun with your varikabi kit.

A) Assembly

The contents of your kit:

- 8 short colored cable ties
- 2 long black cable ties
- 1 bracket and 2 adhesive pads
- 2 motors and 2 rubber caps
- 1 plug board and 1 resistor
- 2 colored LEDs and 2 rubber grommets
- 3 light sensors and 2 transistors
- 1 battery cable and 2 cable bridges
- 41 Fischertechnik bricks (only in the FT set)

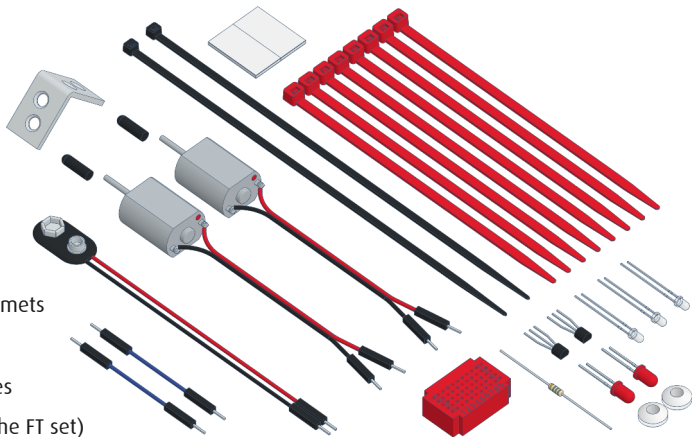

What you need to provide:

- 9 V battery or 9 V rechargeable battery
- small pliers and wire cutters
- black insulating tape if building the varikabi FT
- About one hour of time

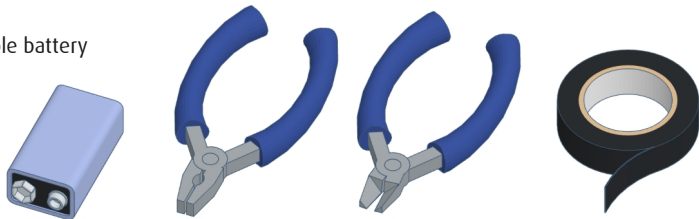

varikabi as a Dog

1)

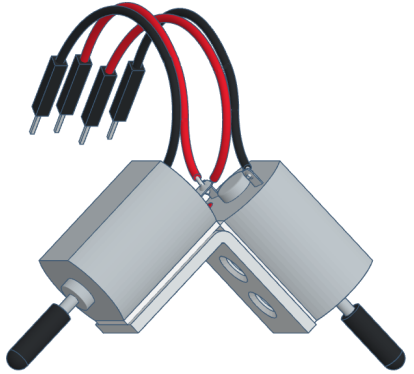
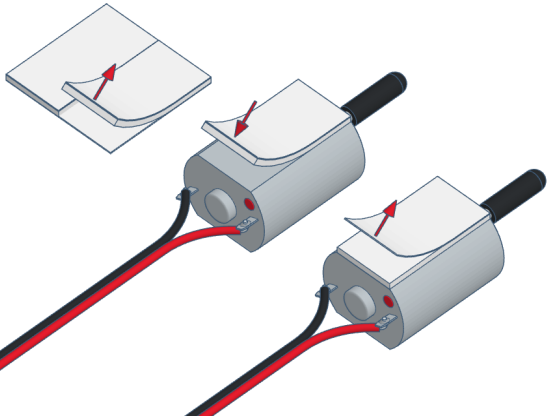
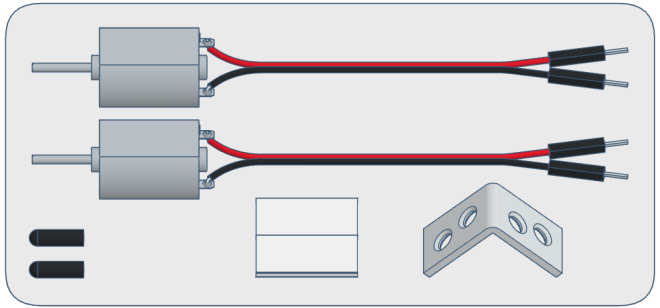
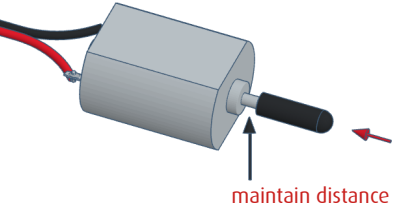

2)

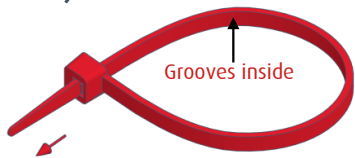

1 x click



Tighten

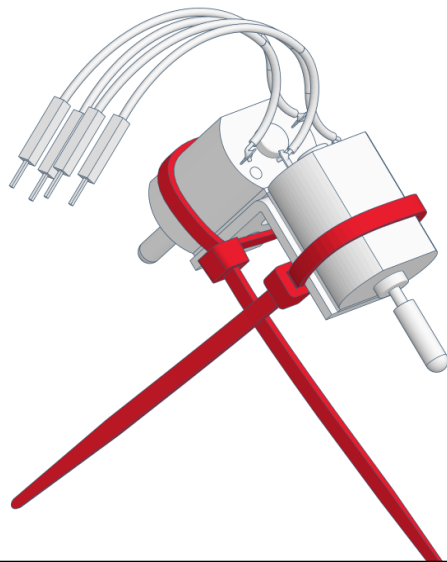
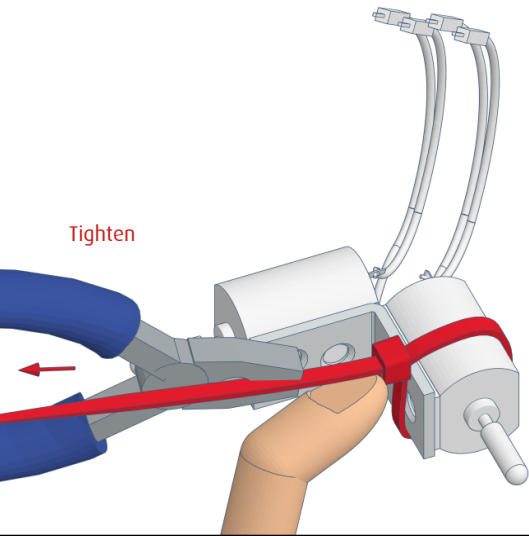

3)

Grooves on the front

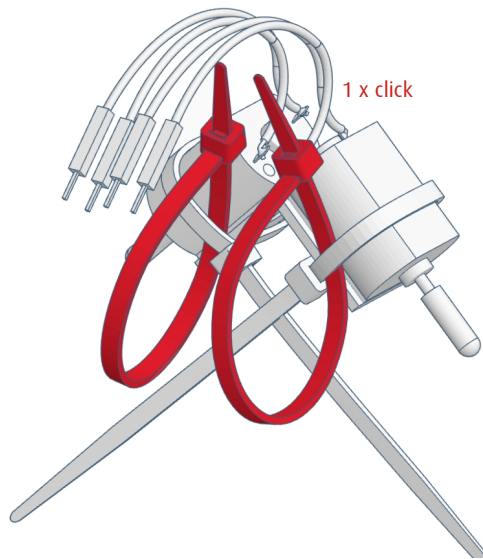
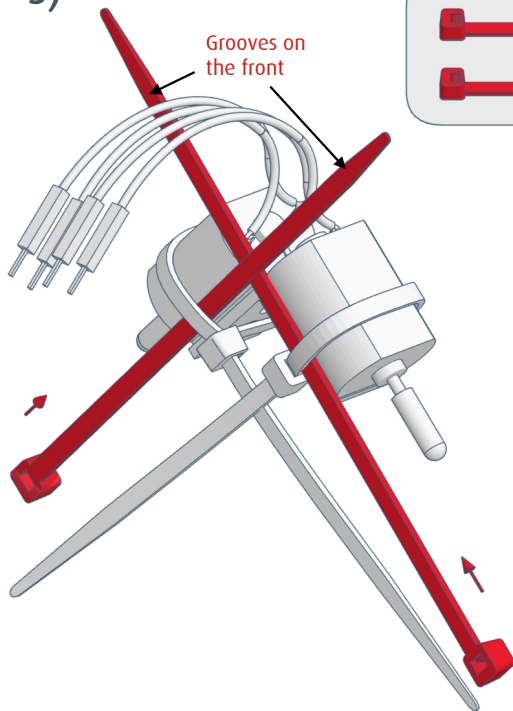

4)

Tighten

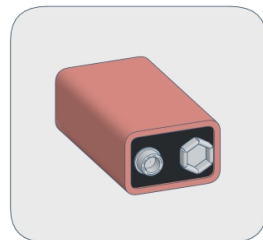
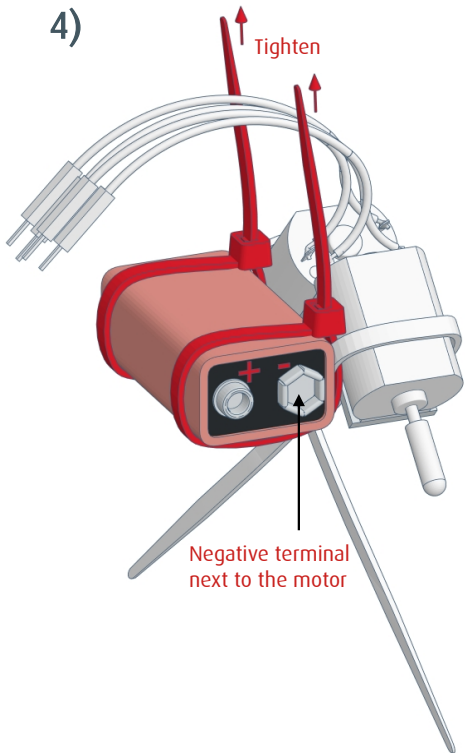

Shorten

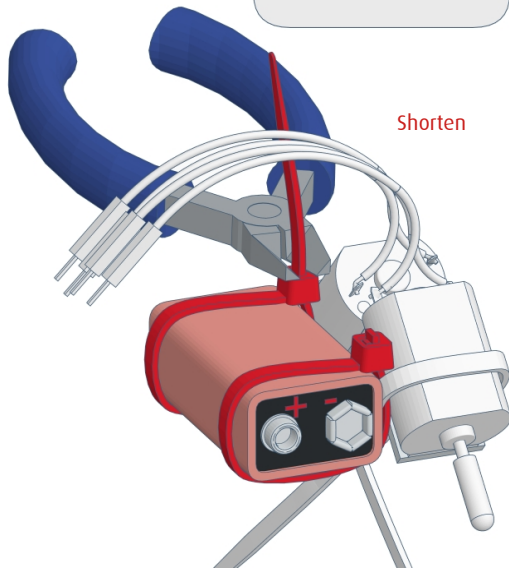

5)

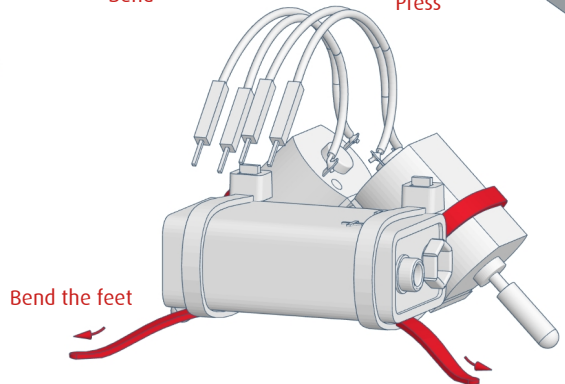
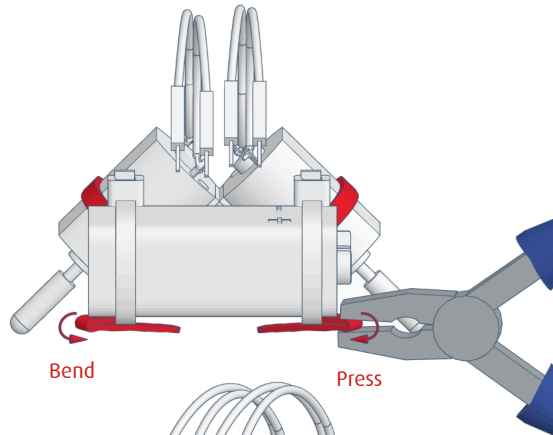
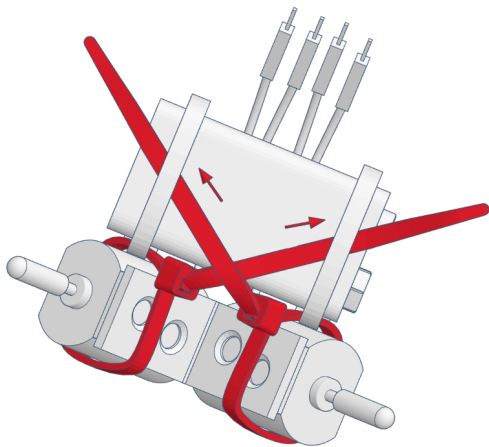

6)

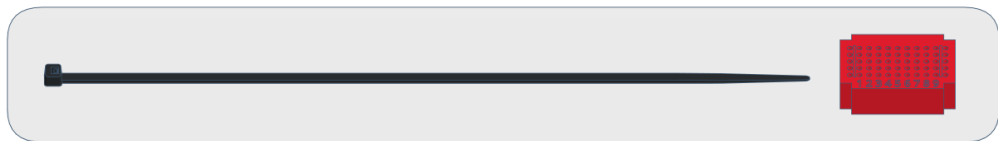
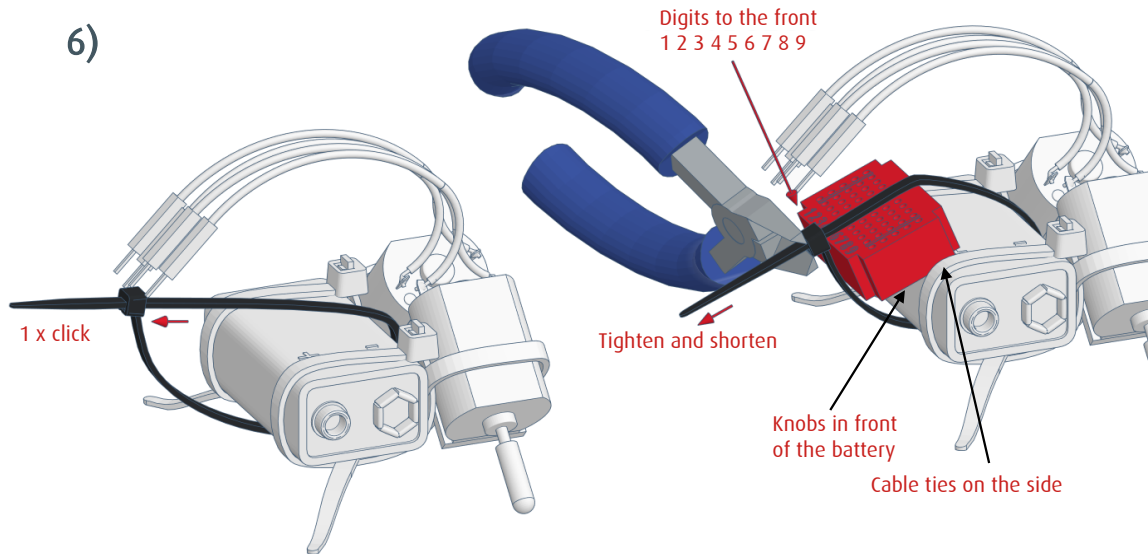

7)

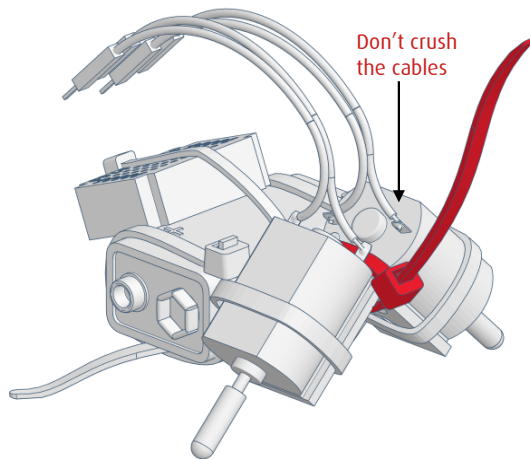
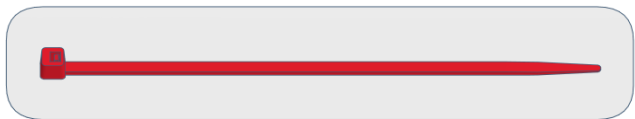
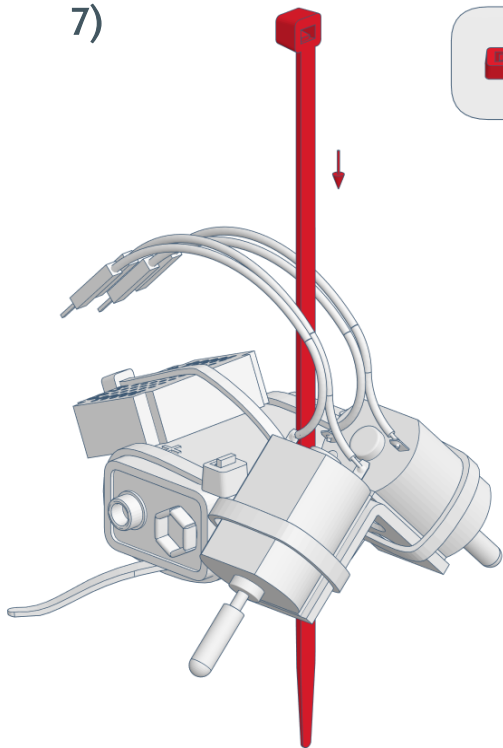

varikabi as a Sea Lion

1)

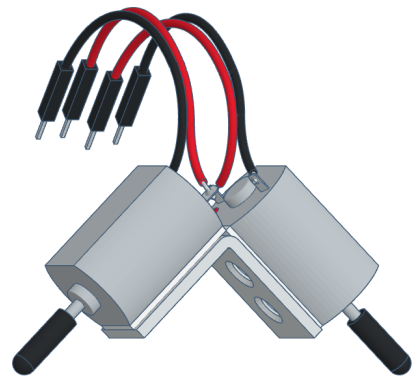
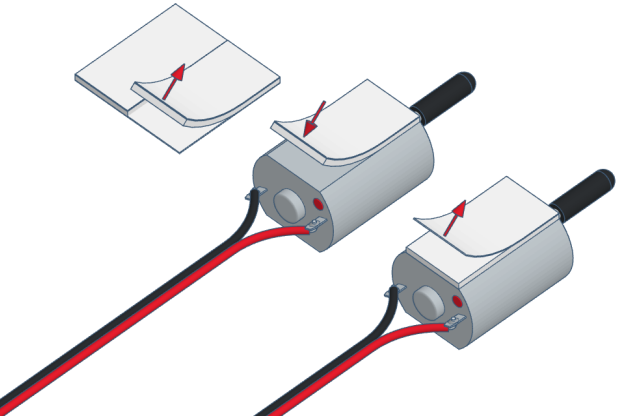
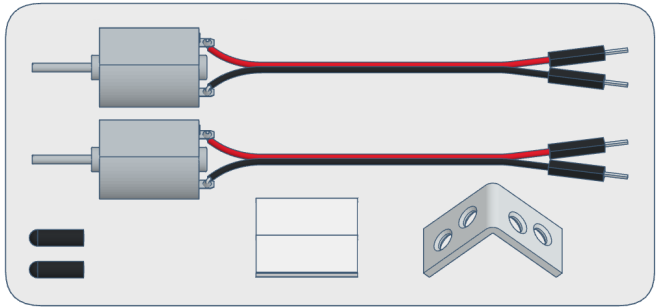
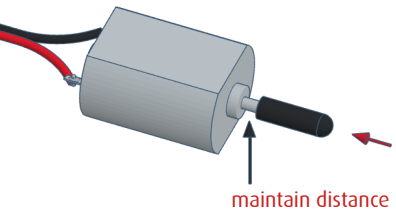

2)

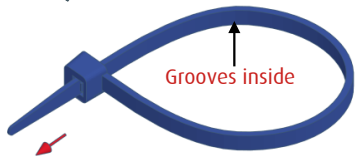

Grooves inside

1 x click



Tighten

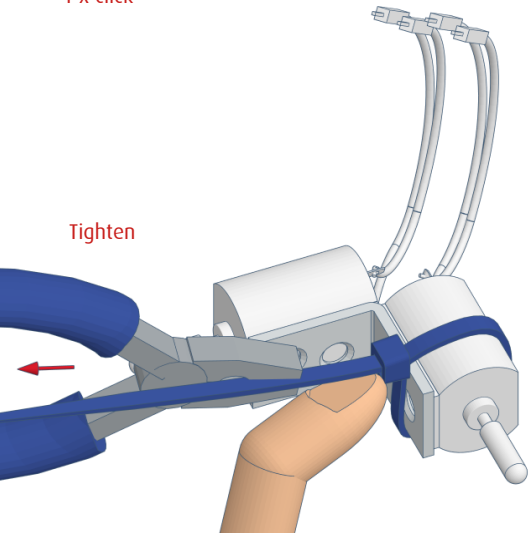

Shorten

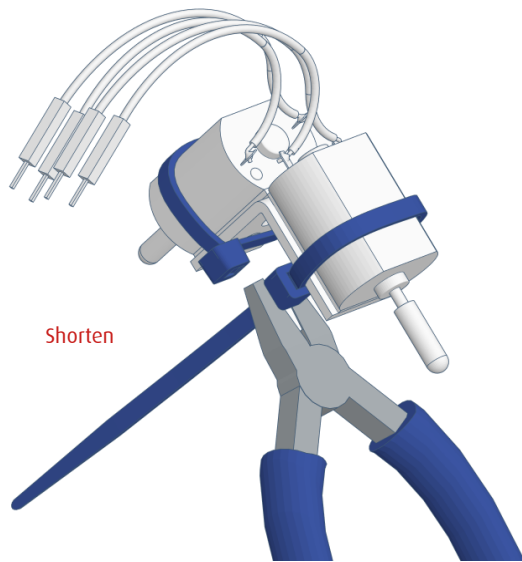

3)

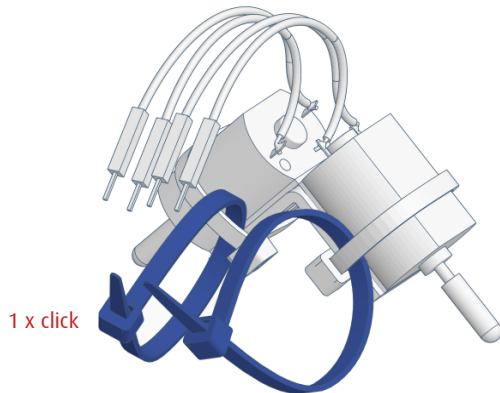
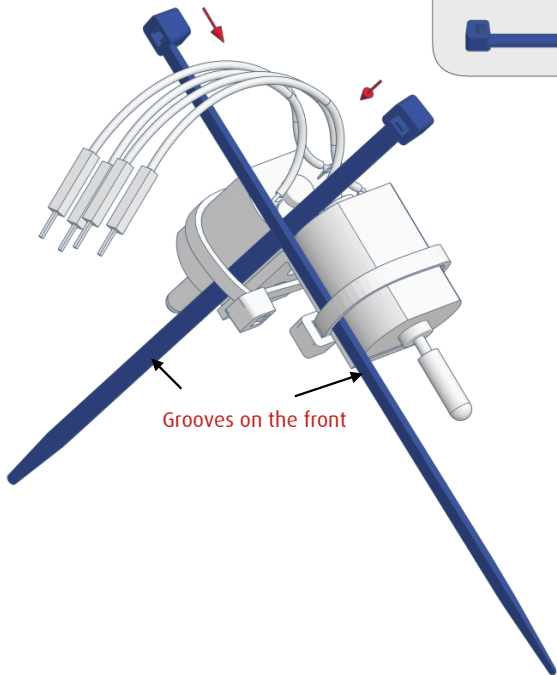

4)

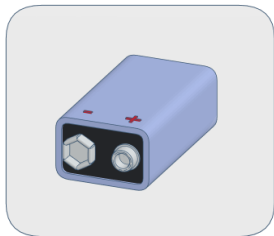

Bend the cables
backwards

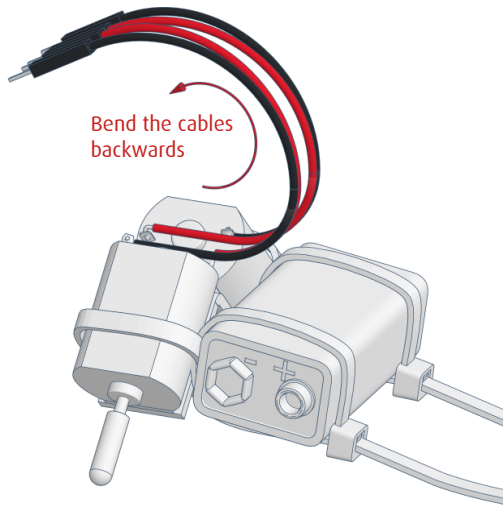
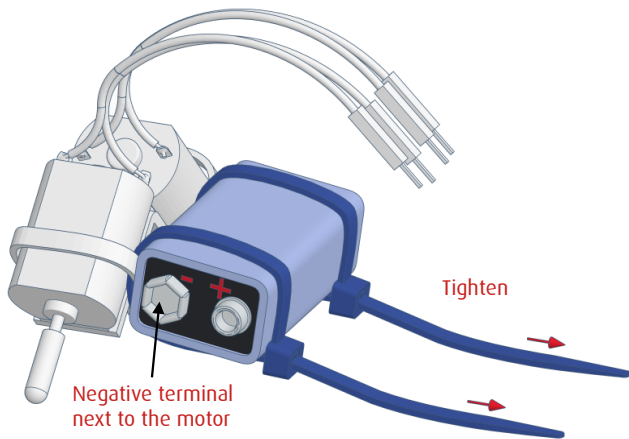

5)

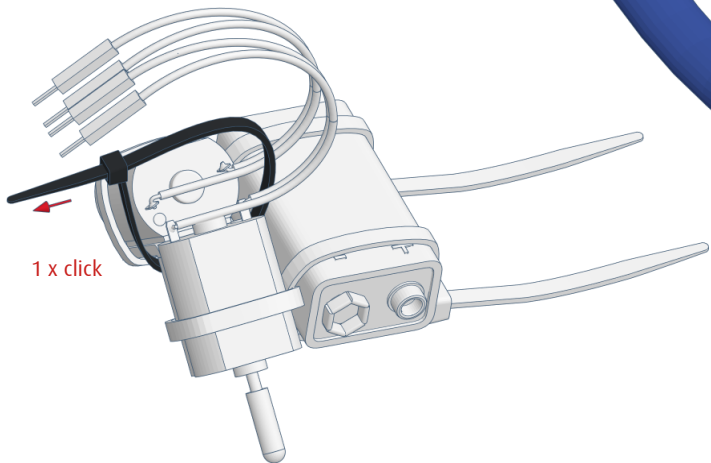

1 x click

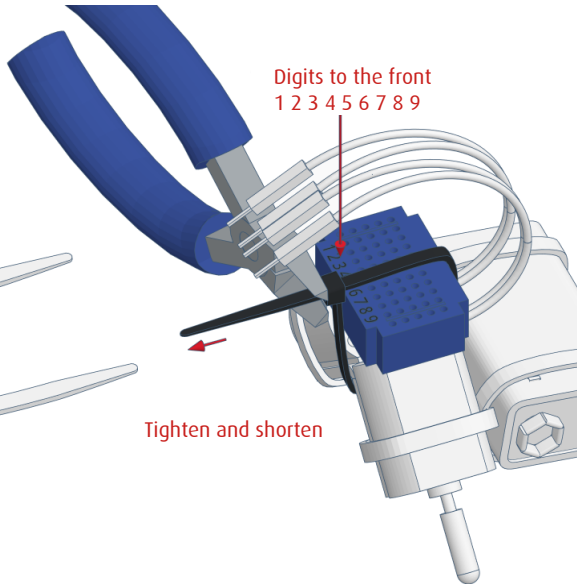

Digits to the front
1 2 3 4 5 6 7 8 9

Tighten and shorten



varikabi as a Frog

1)

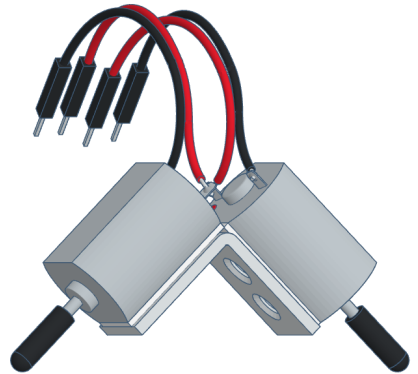
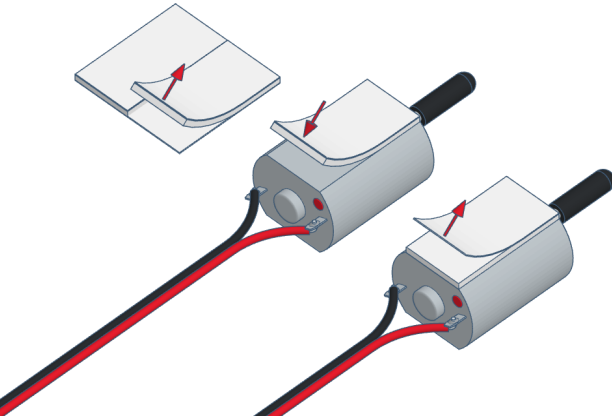
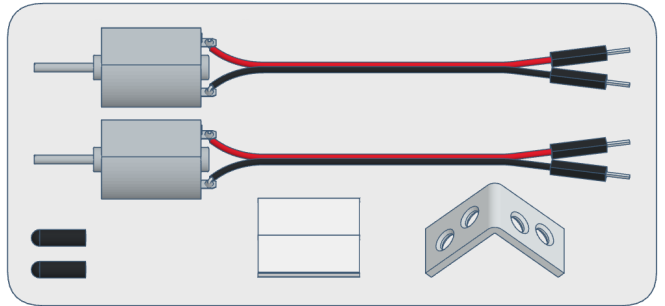
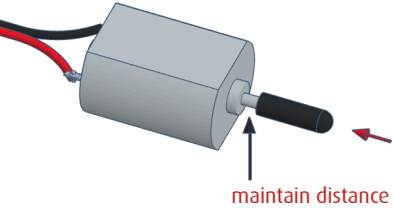

2)

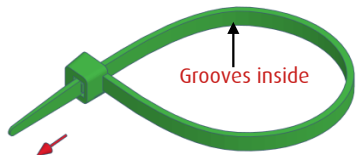

1 x click

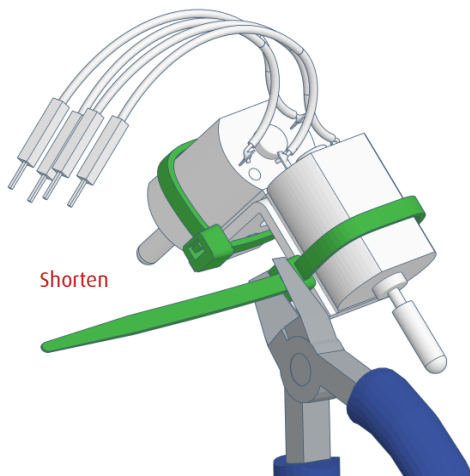
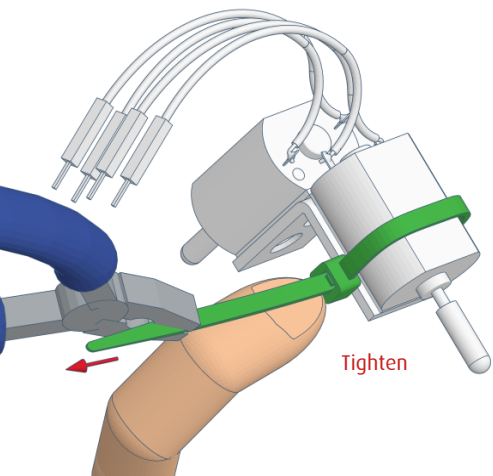
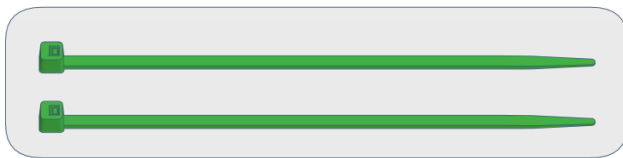

3)

Don't crush
the cables

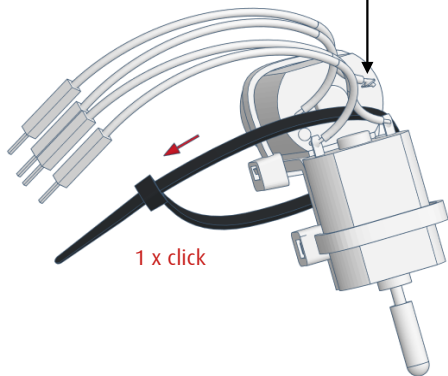

Digits to the front
1 2 3 4 5 6 7 8 9

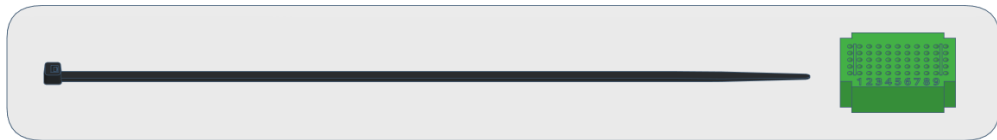
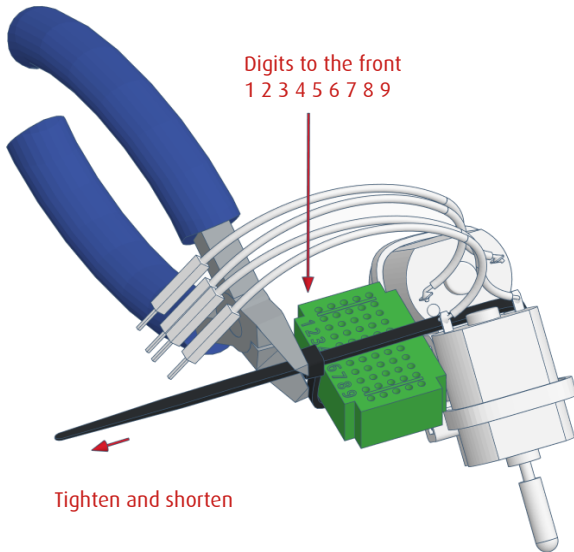

4)

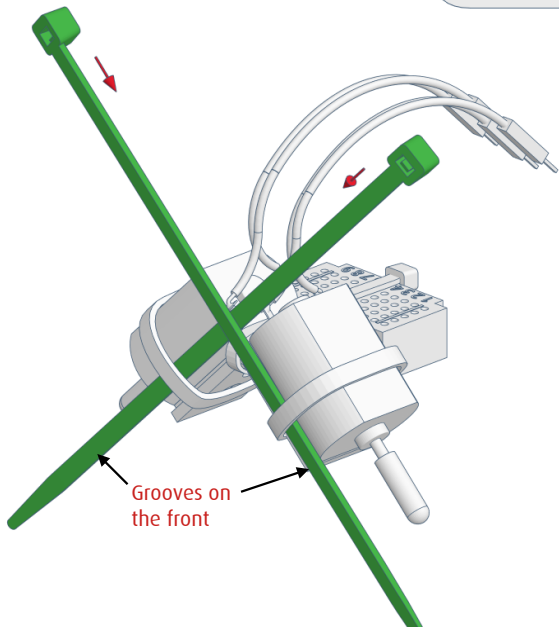
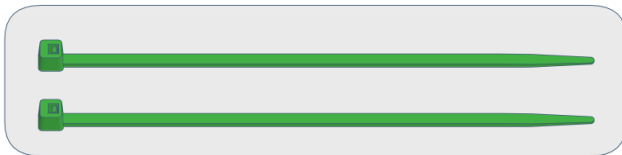

Grooves on the front

1 x click

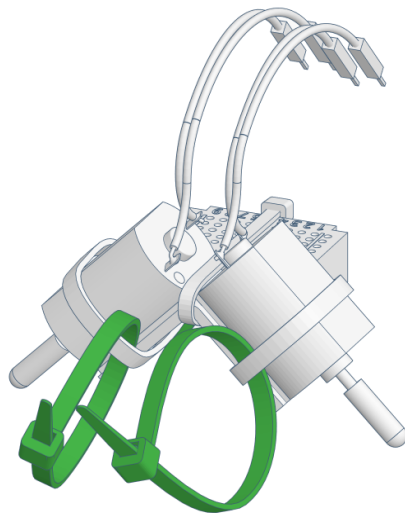

5)

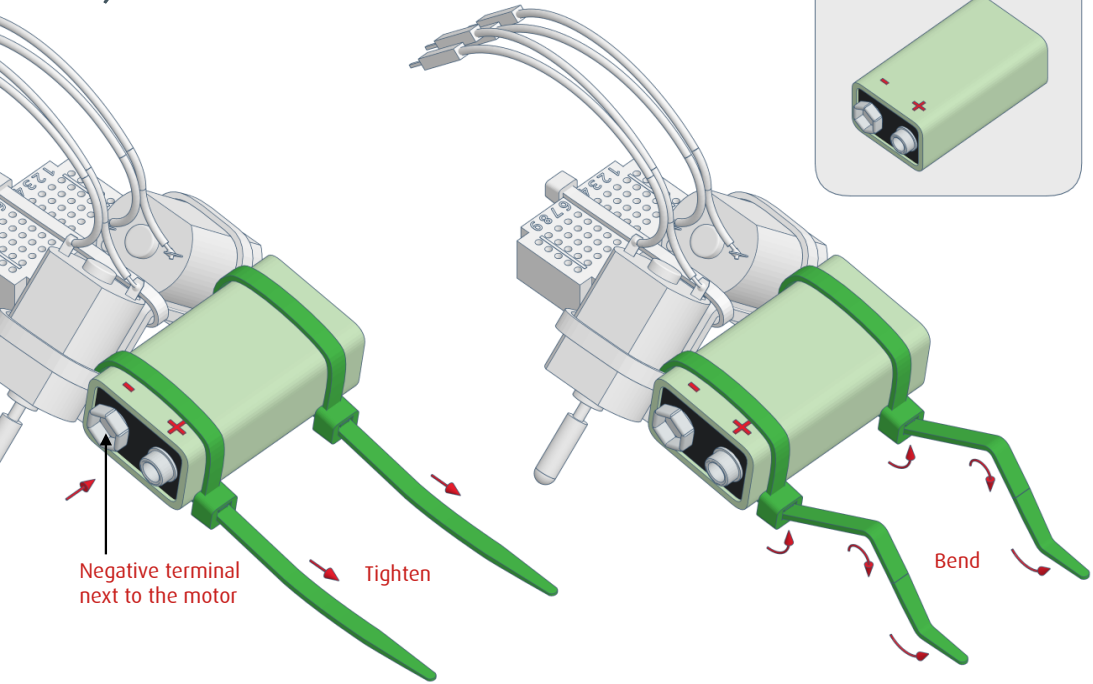

varikabi as a Bird

1)

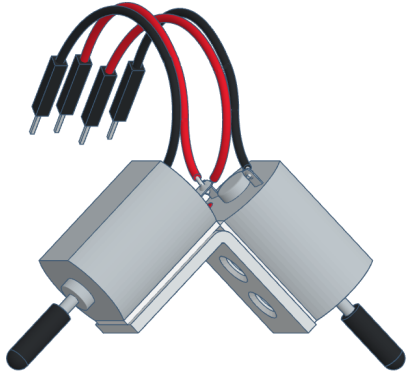
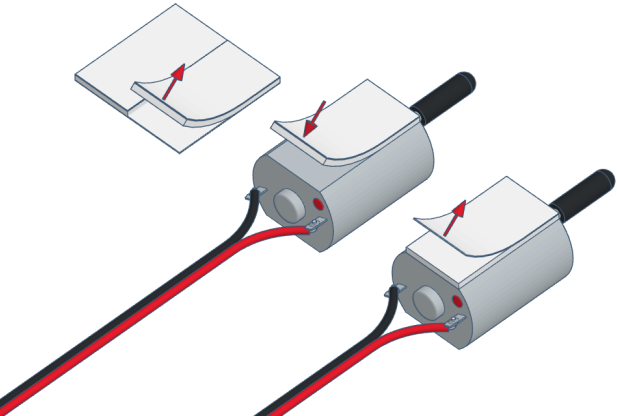
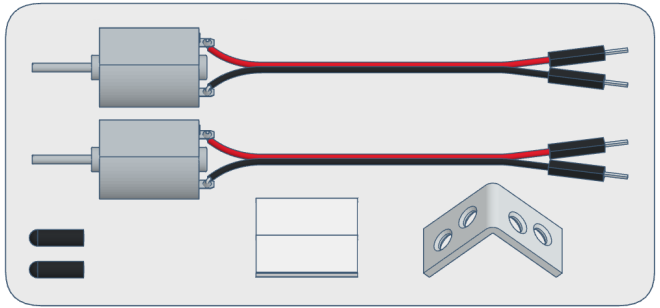
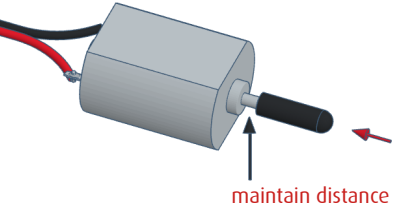

2)

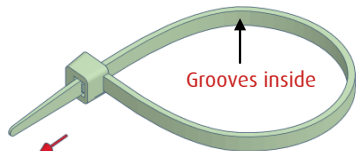

1 x click

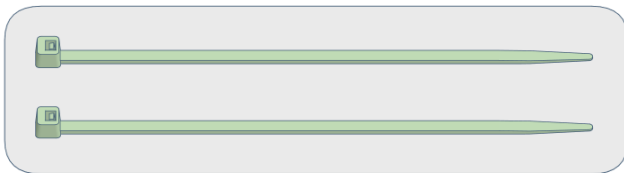

Tighten

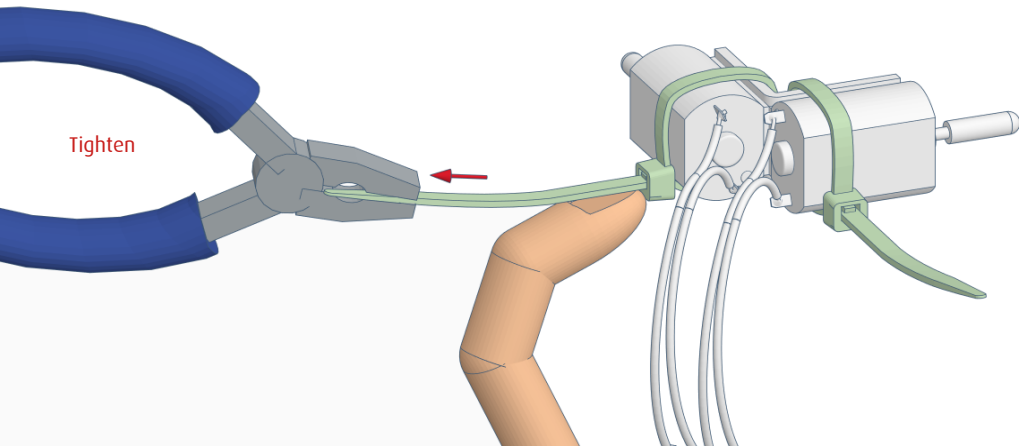

3)

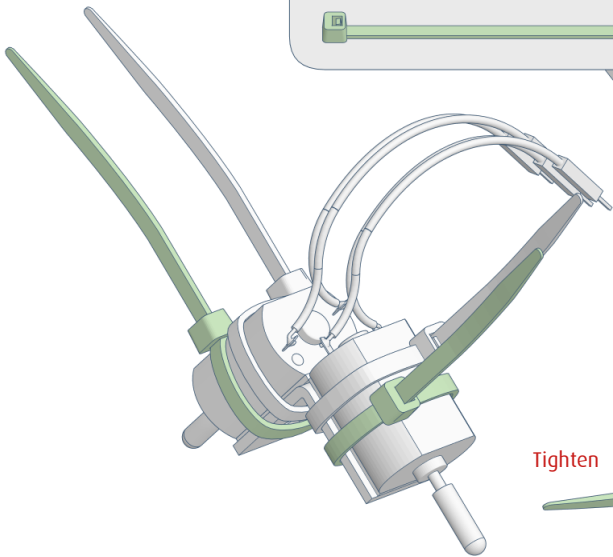

Tighten

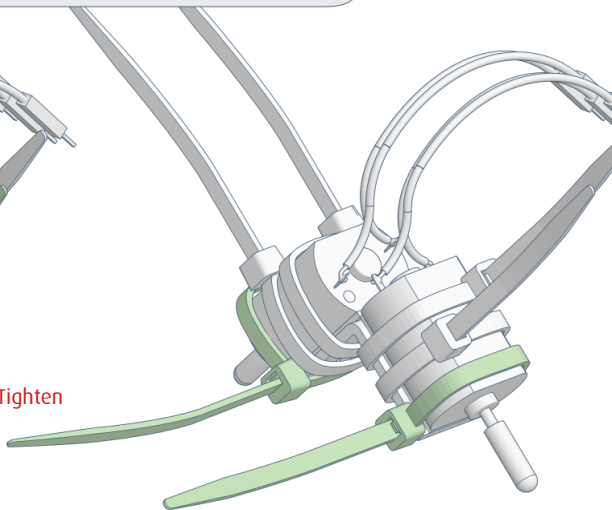

4)

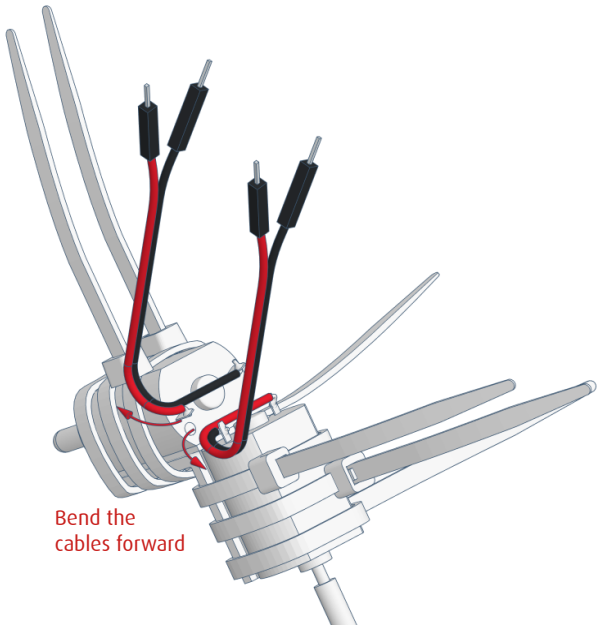
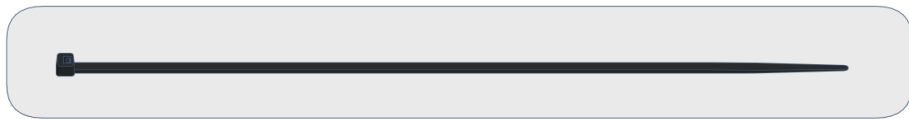

Bend the
cables forward

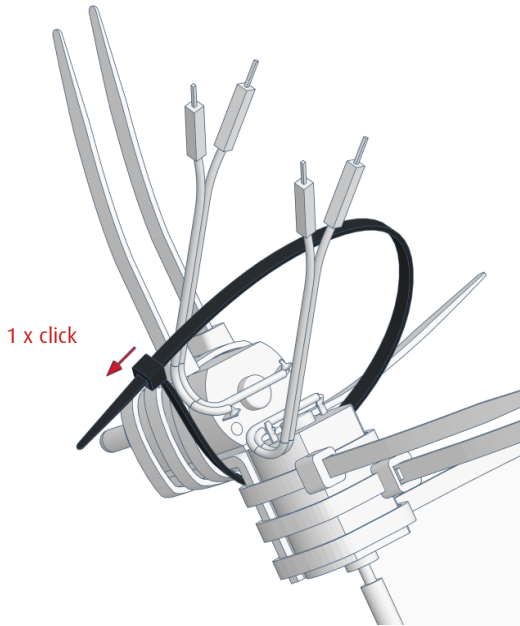

1 x click

5)

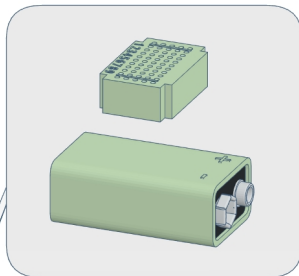

Digits to the front
1 2 3 4 5 6 7 8 9

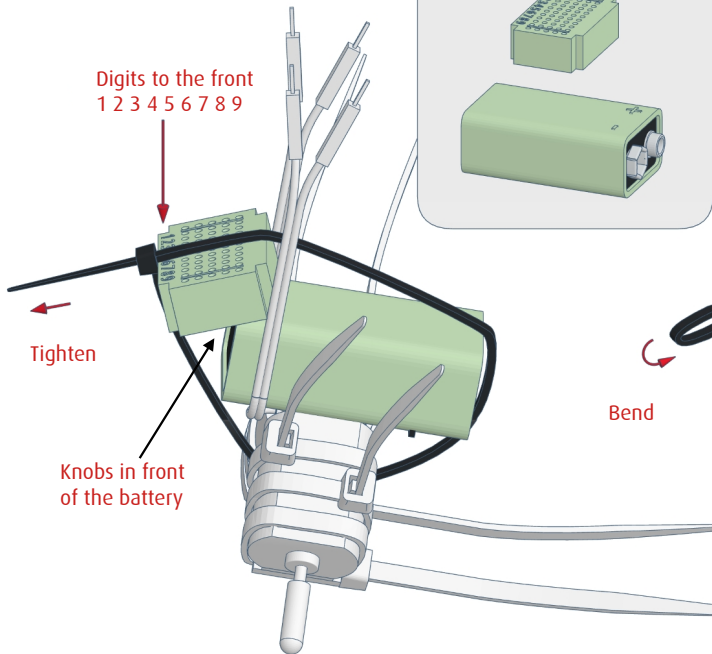

Bend

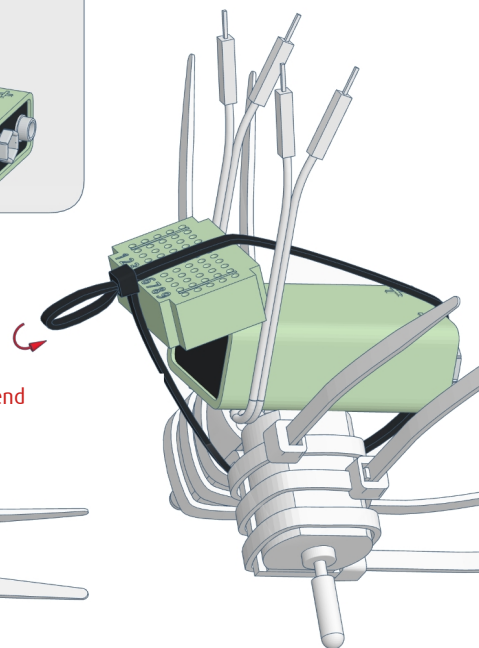

varikabi as a Giraffe

1)

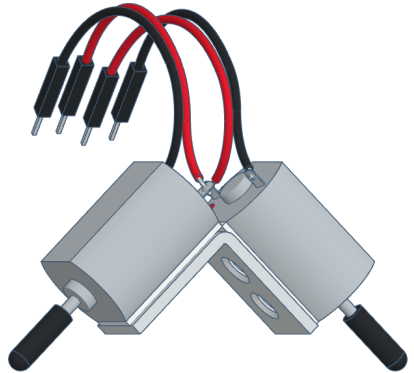
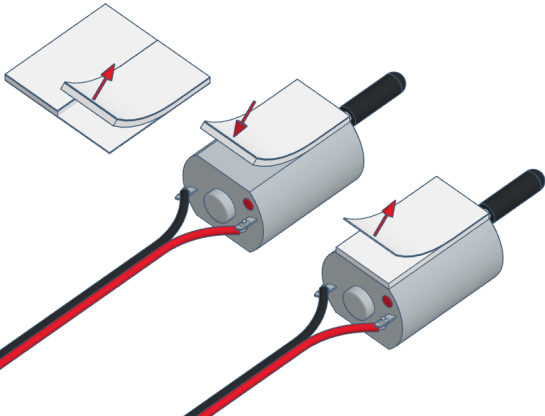
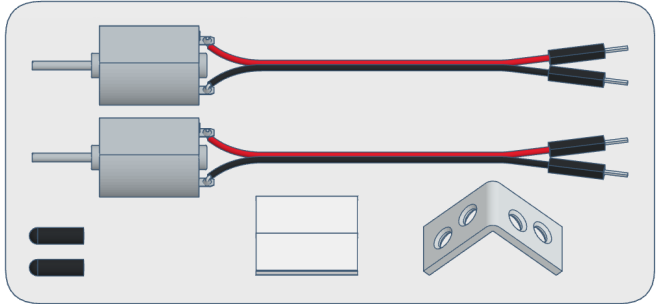
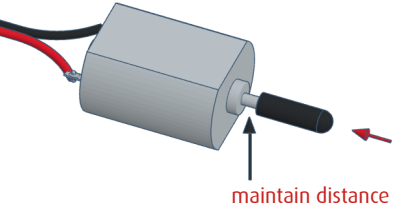

2)

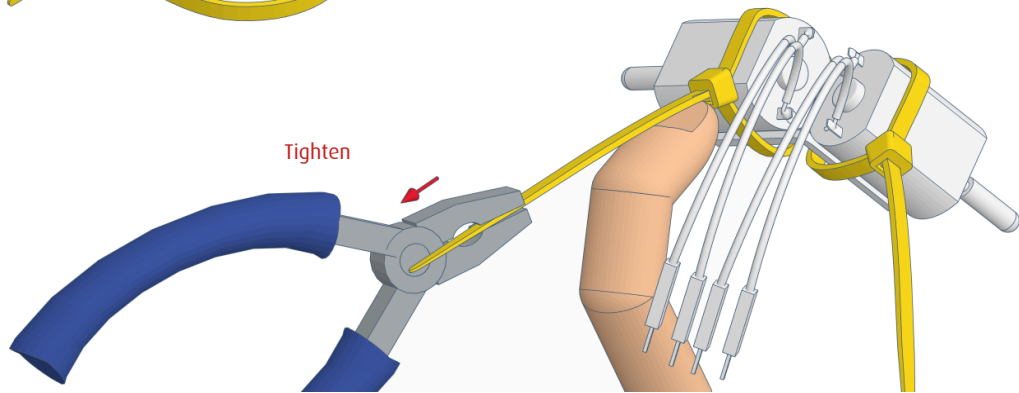
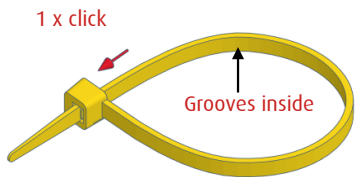
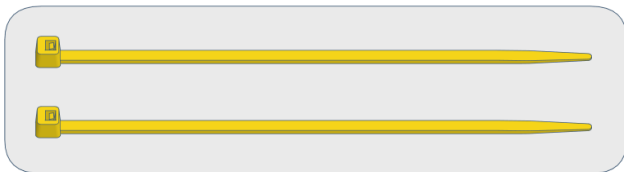

3)

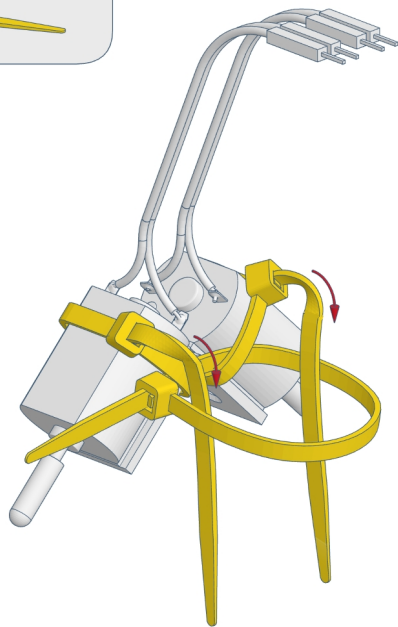
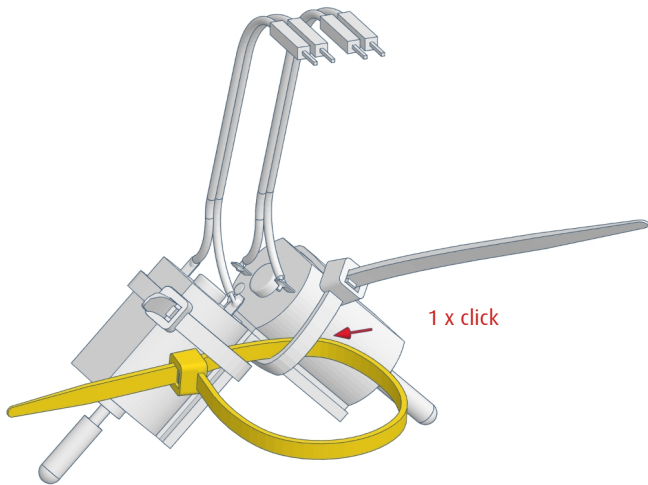
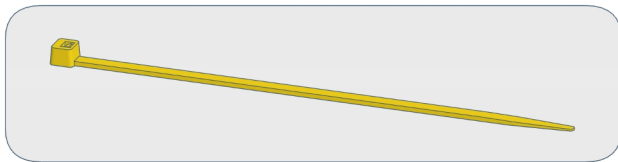

4)

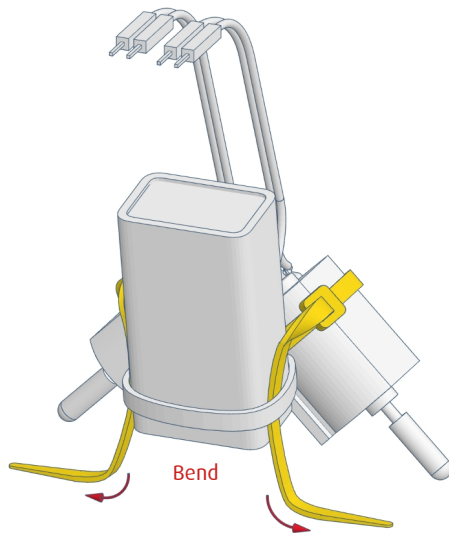
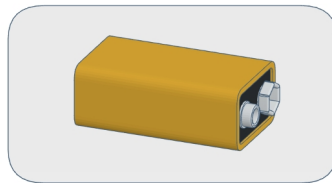
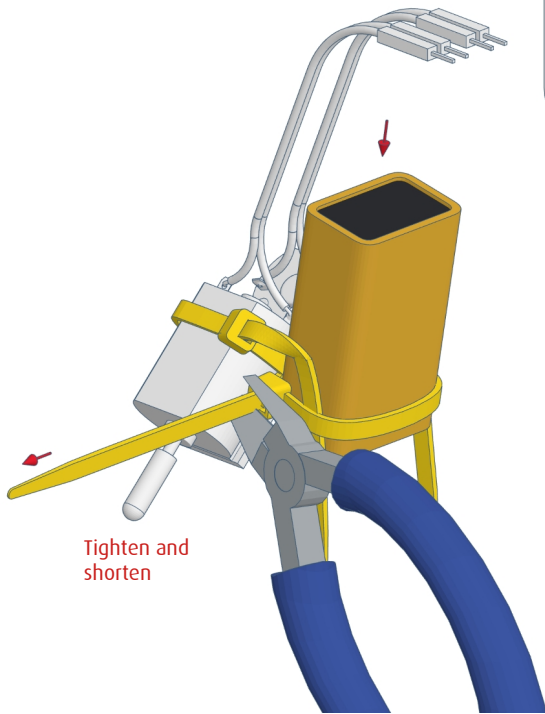

5)

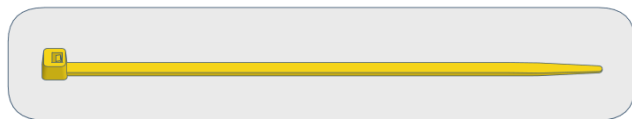
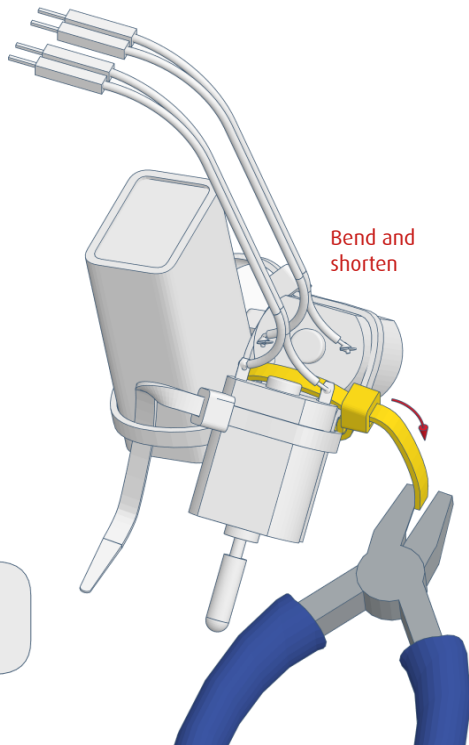
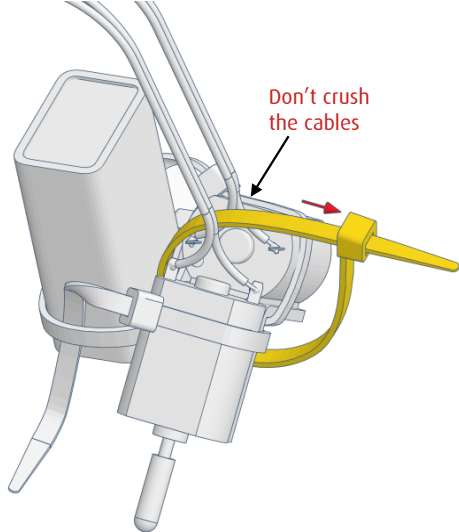

6)

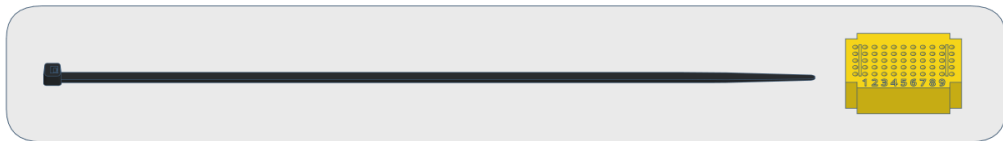
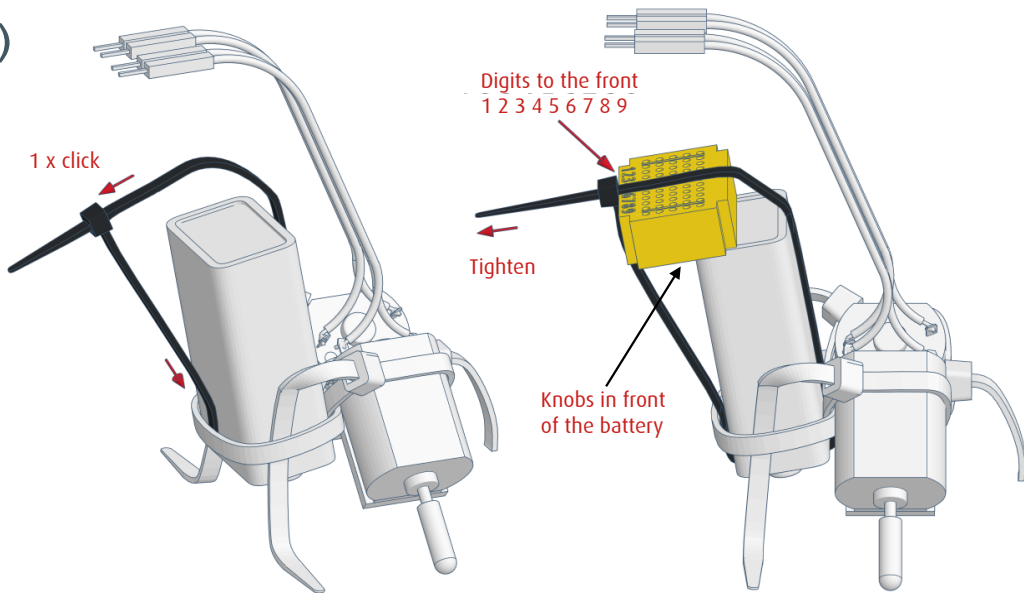

7)

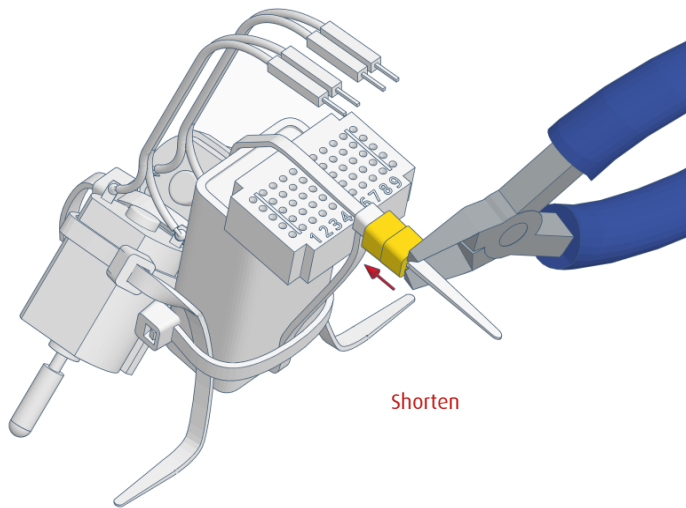
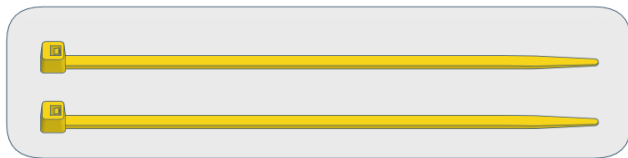

varikabi as a Mouse

1)

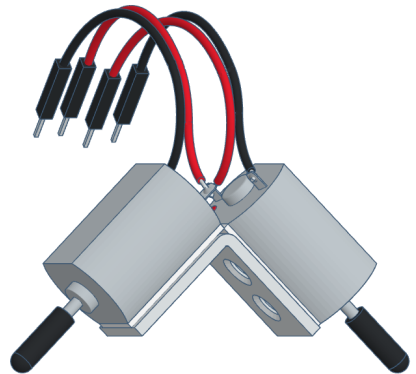
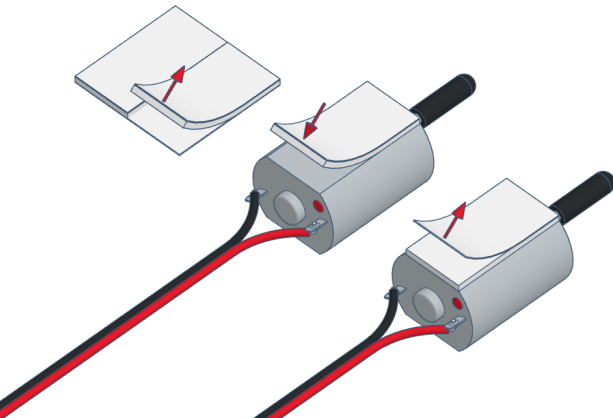
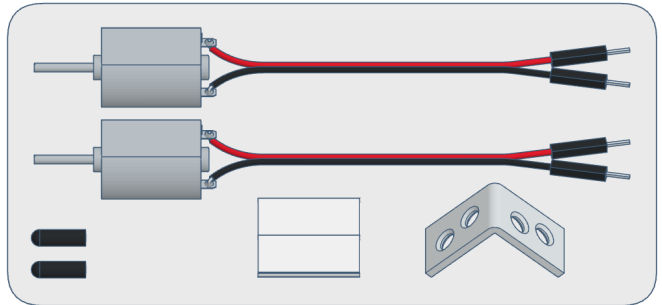
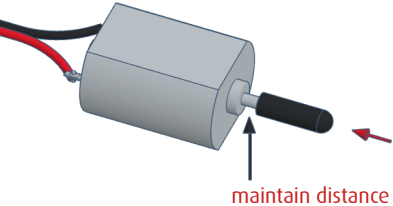

2)

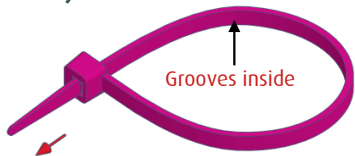

1 x click

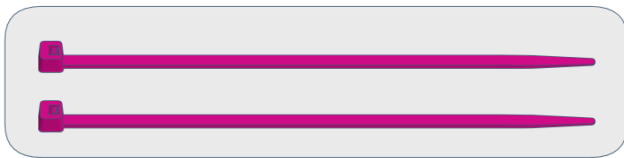

Tighten

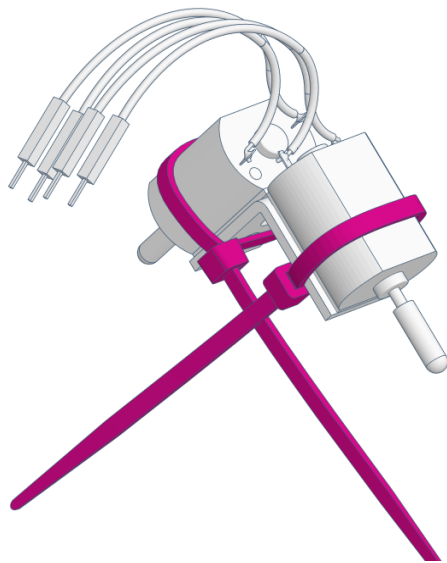
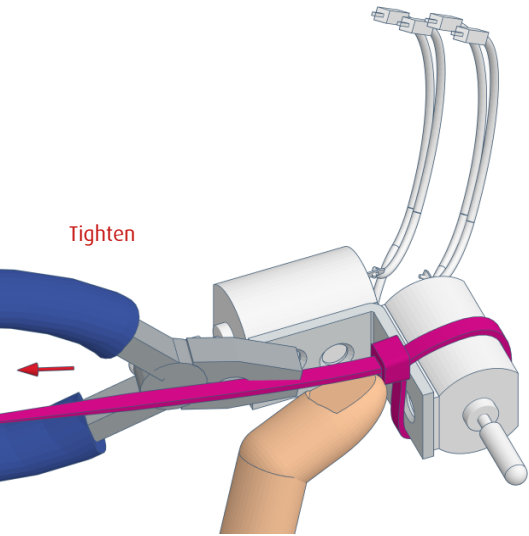

3)

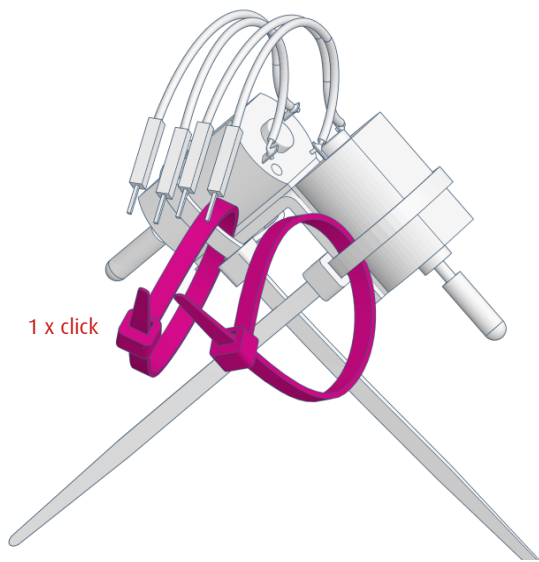
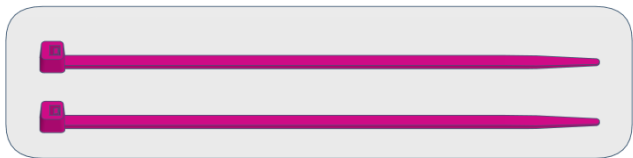
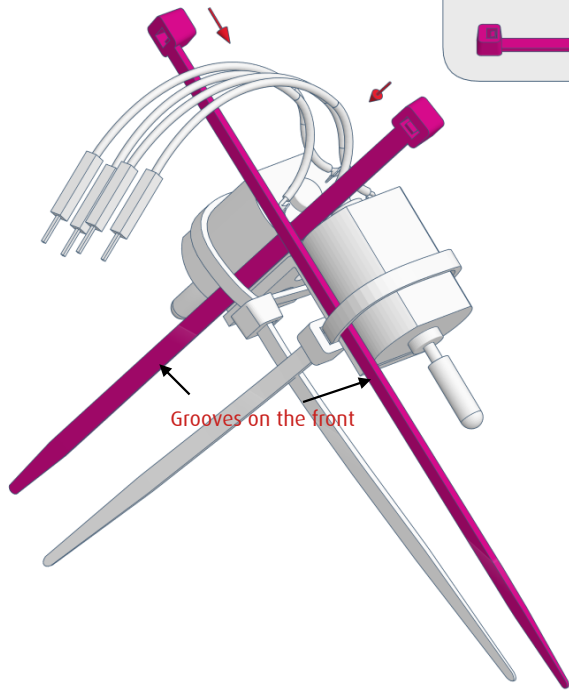

4)

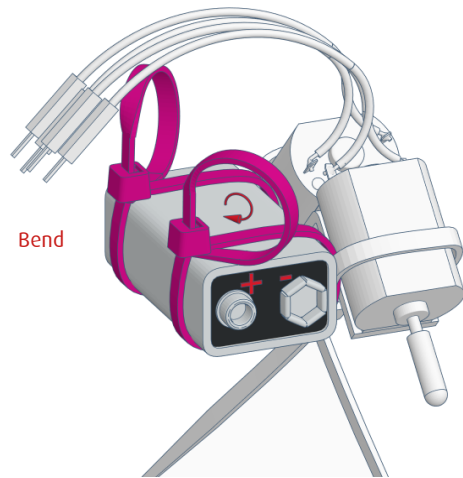
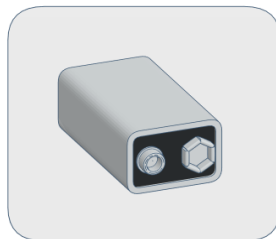
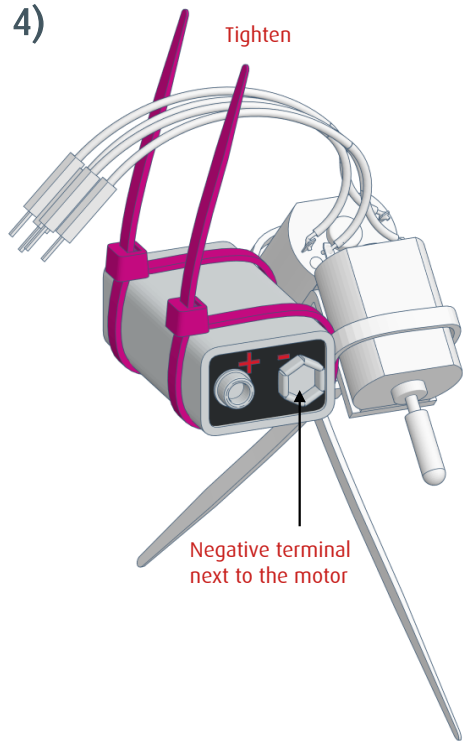

5)

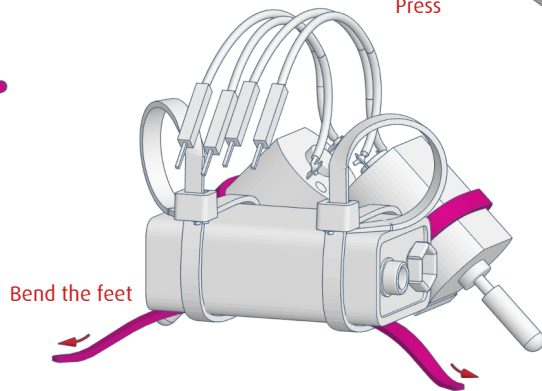
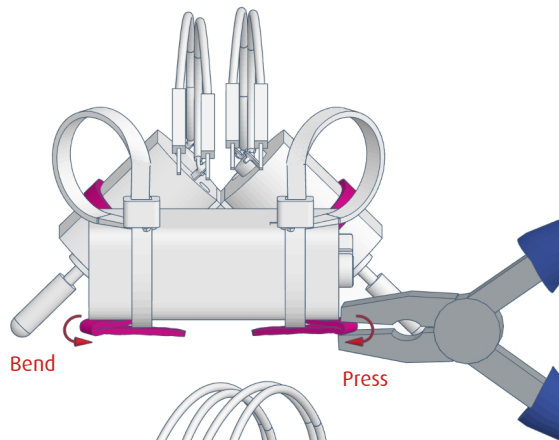
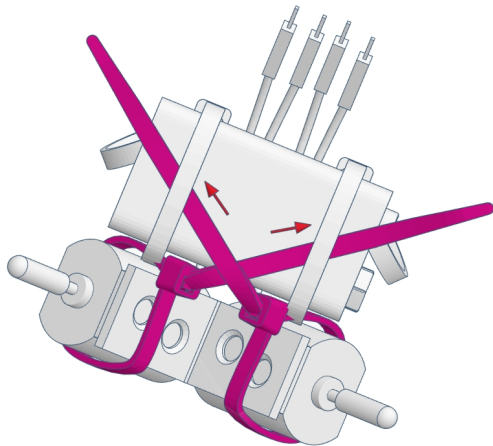

6)

1 x click

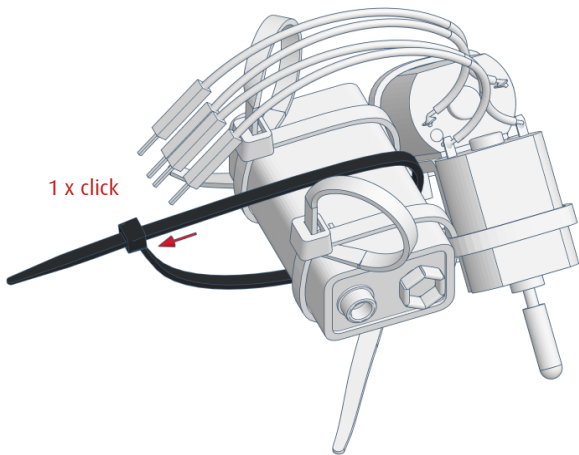

Digits to the front
1 2 3 4 5 6 7 8 9

Tighten and shorten

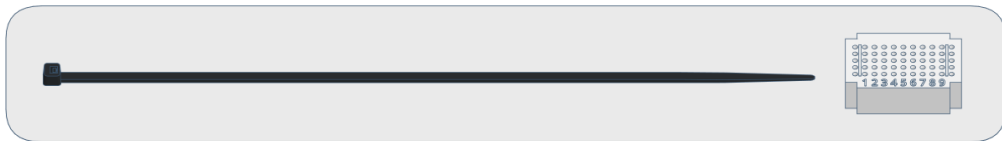
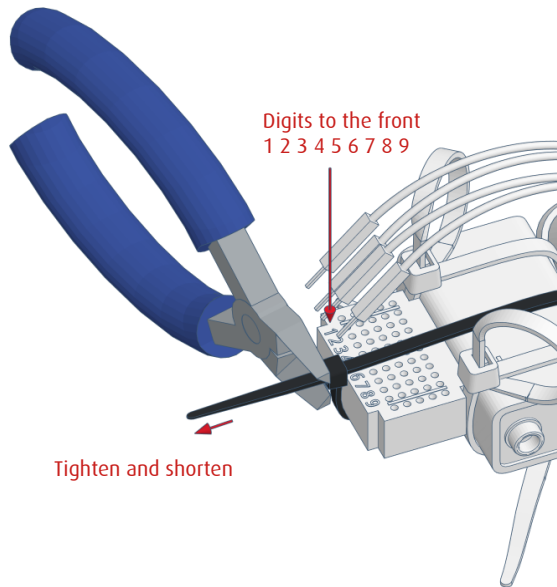

7)

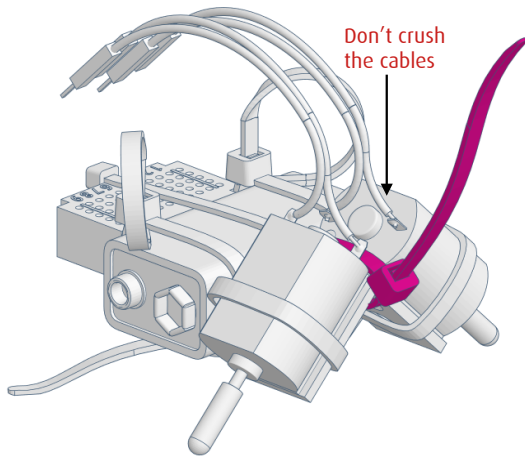
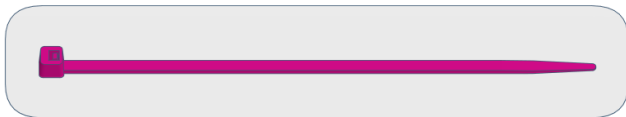
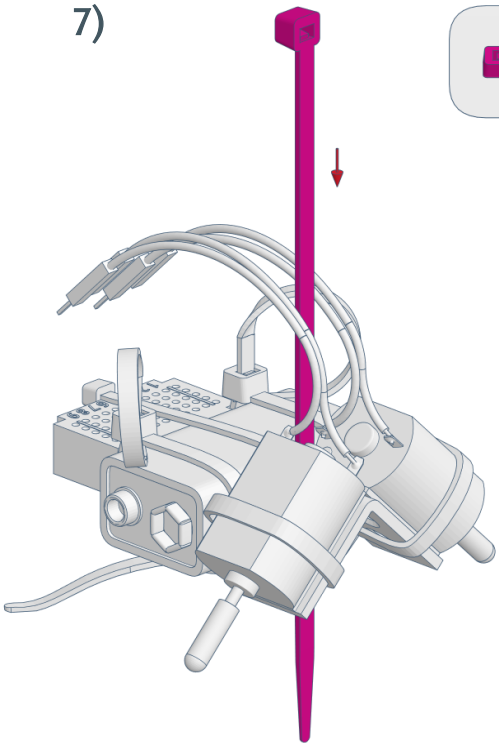

varikabi as a Beetle

1)

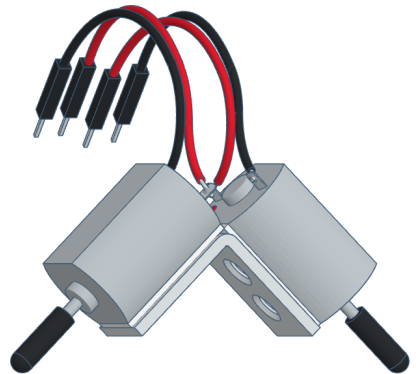
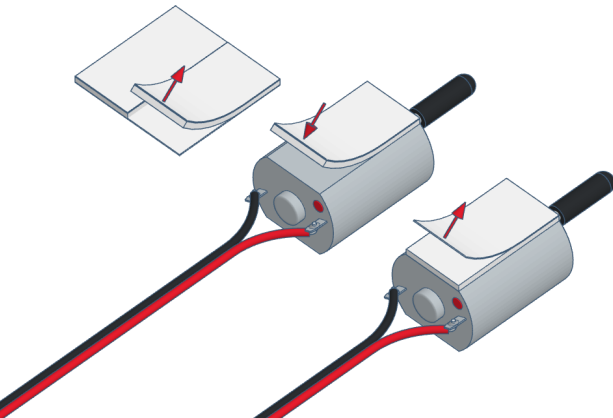
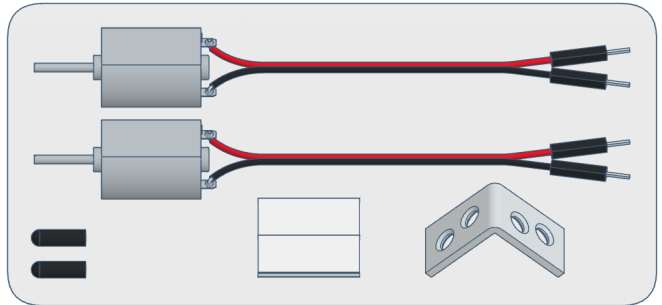
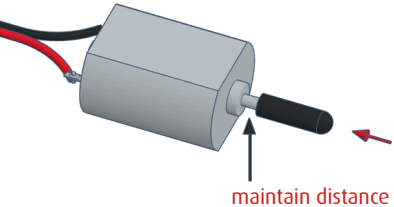

2)

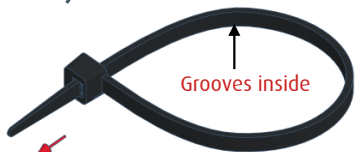

Grooves inside

1 x click

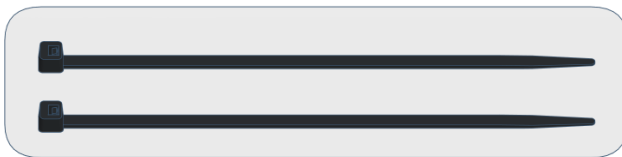

Tighten

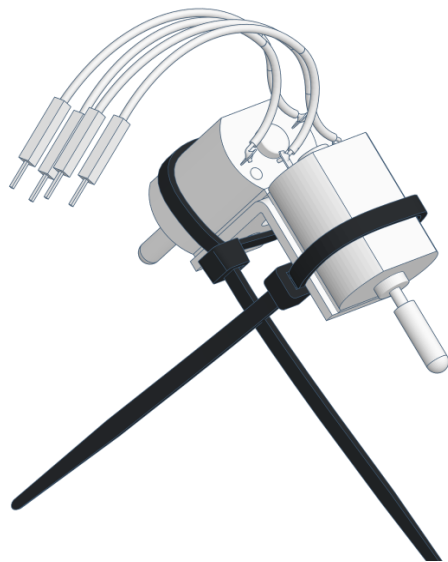
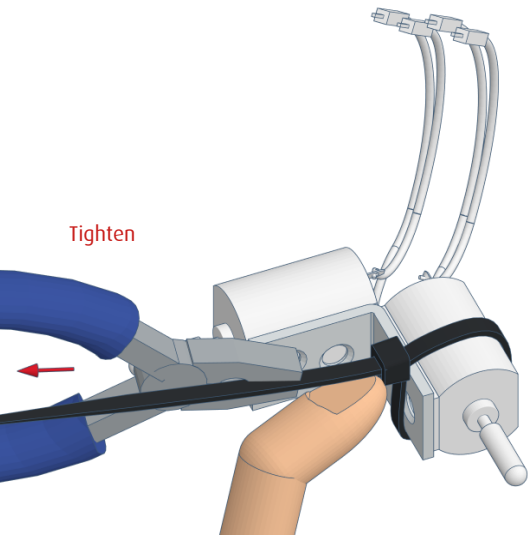

3)

Grooves on the front

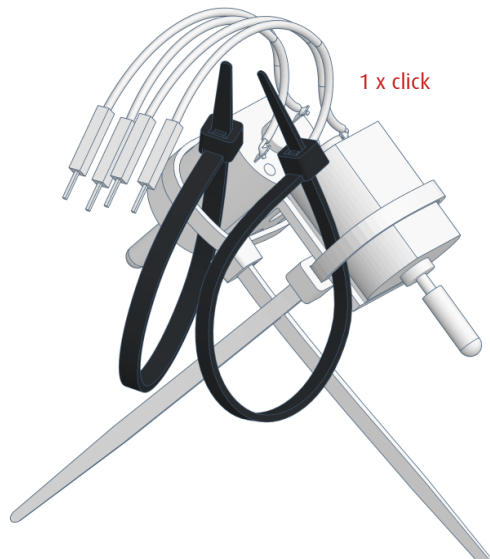
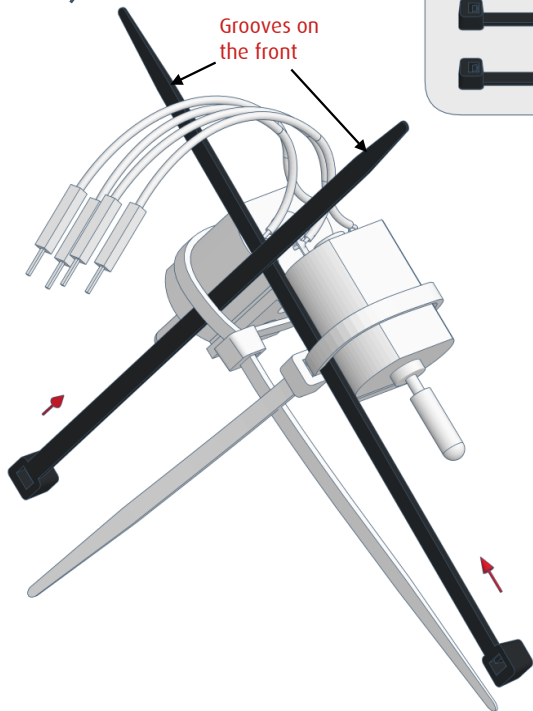
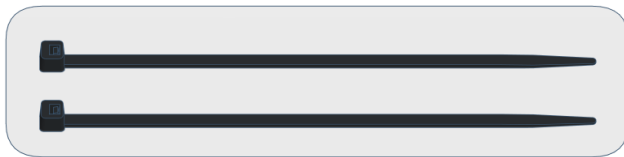

4)

Tighten

Negative terminal
next to the motor

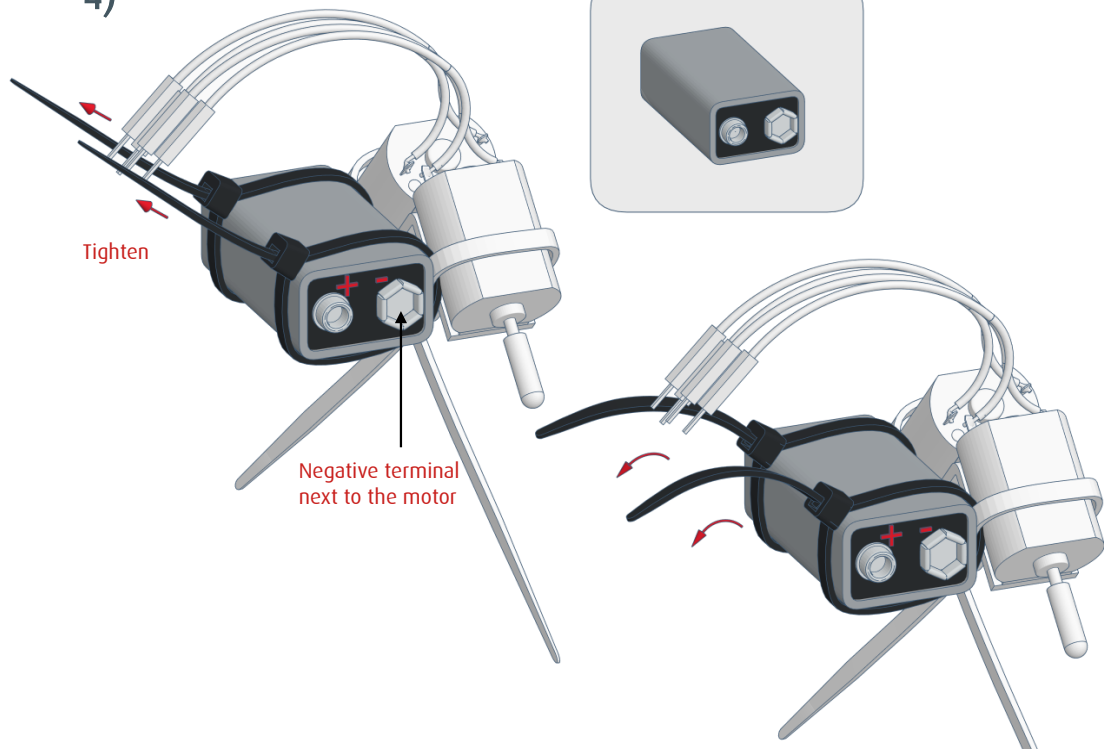
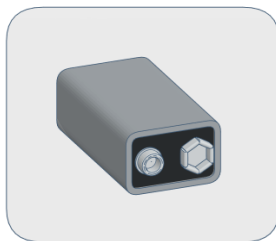

5)

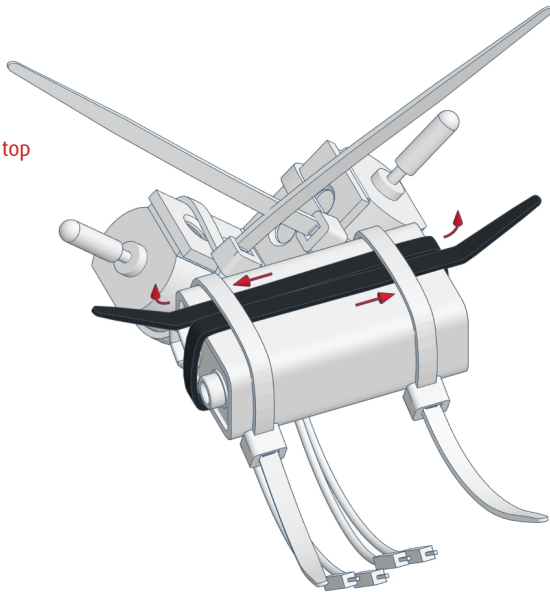
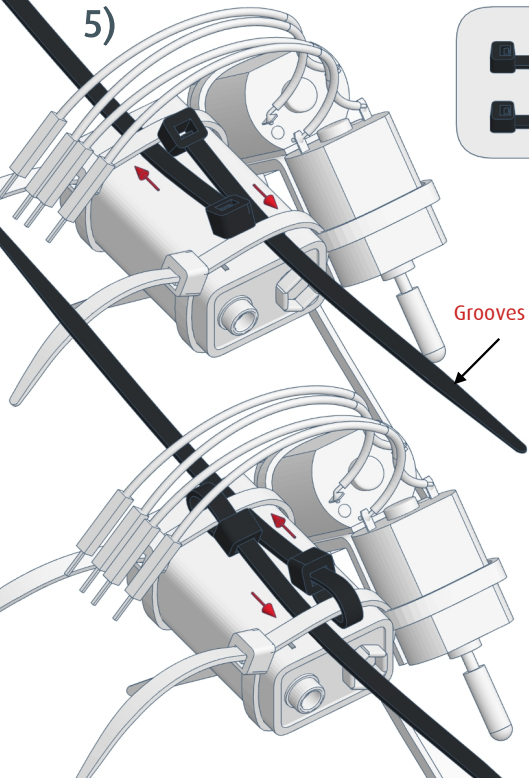

6)

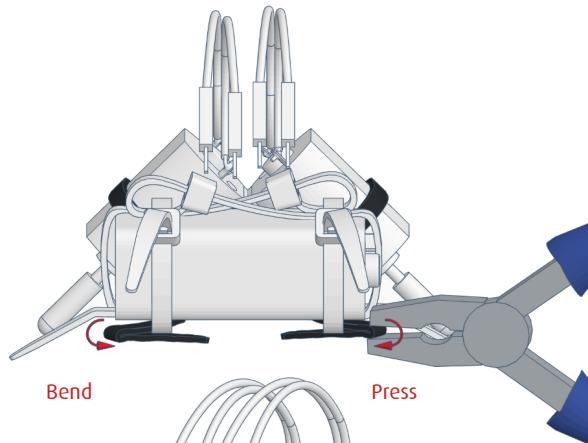
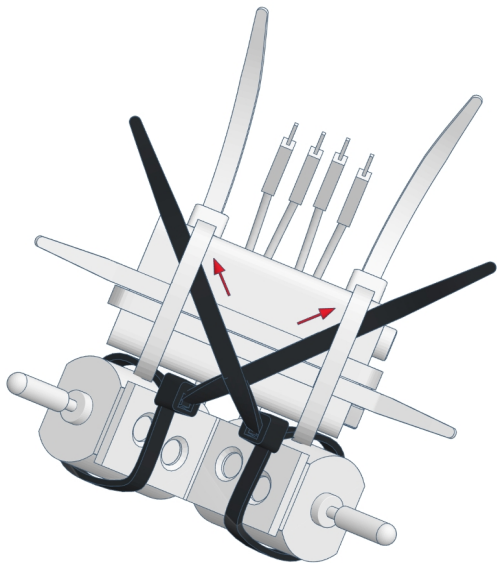

Bend

Press

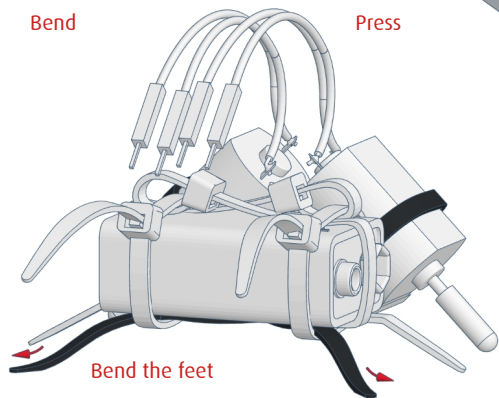

Bend the feet

7)

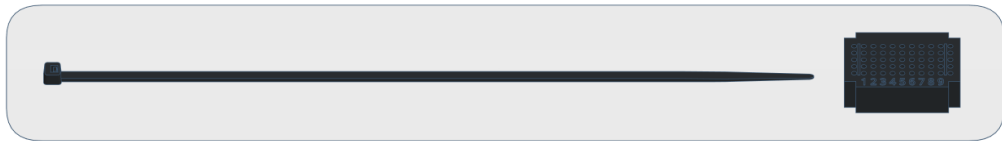
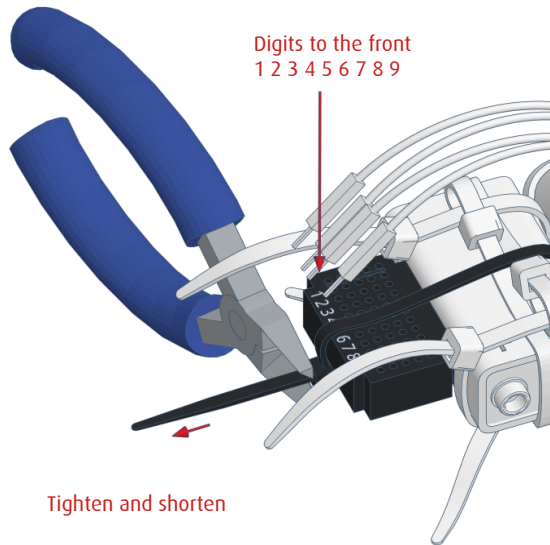
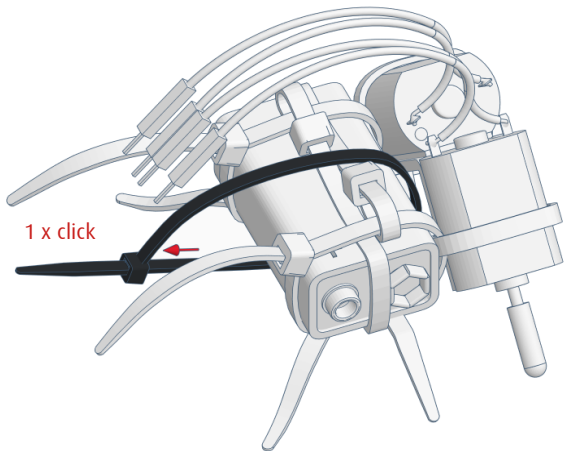

varikabi FT

1)

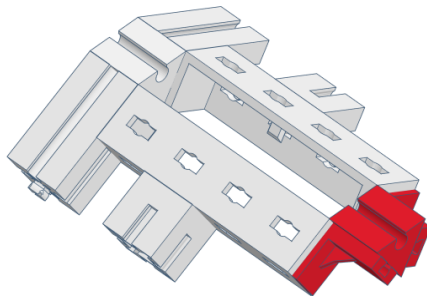
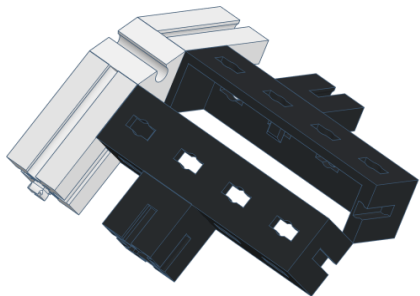
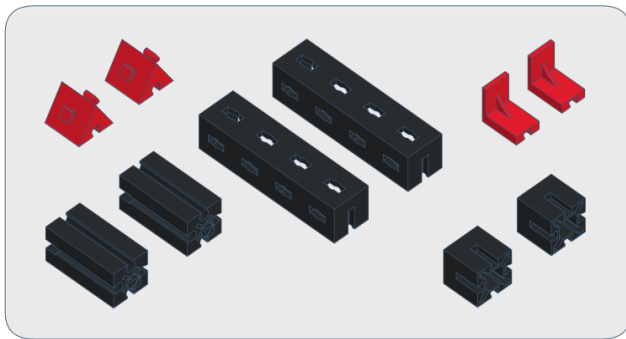
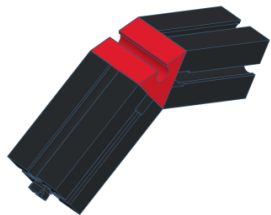

2)

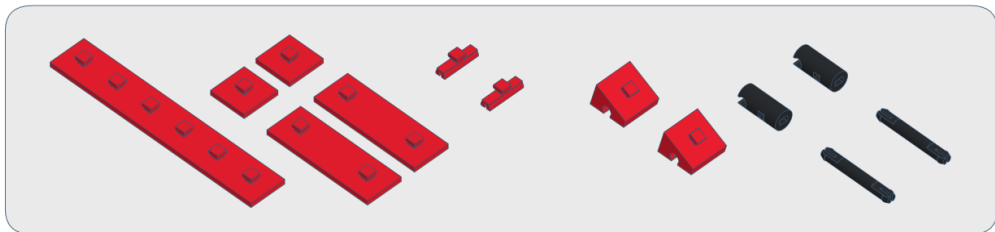
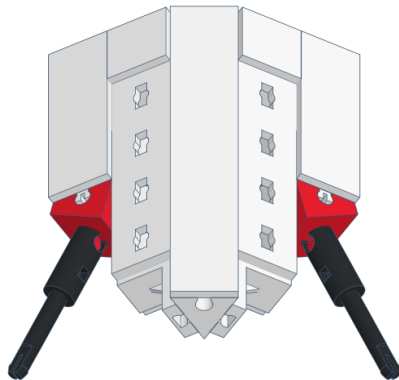
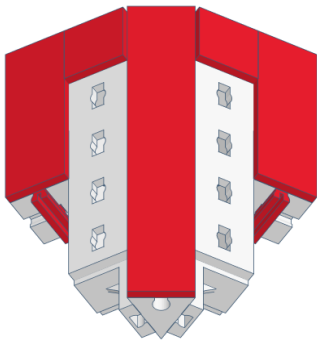

3)

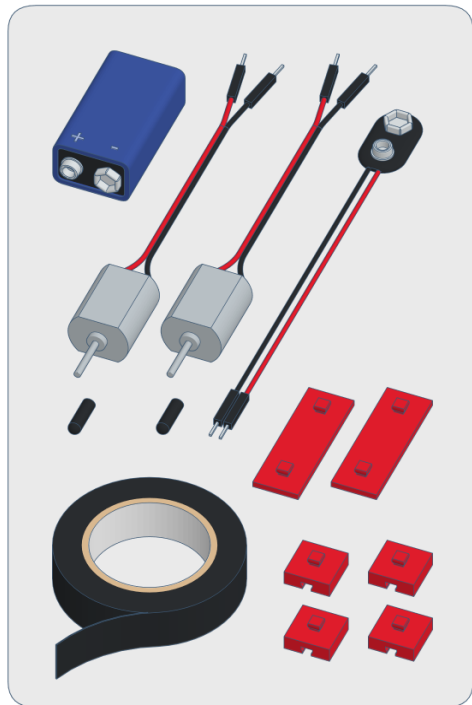
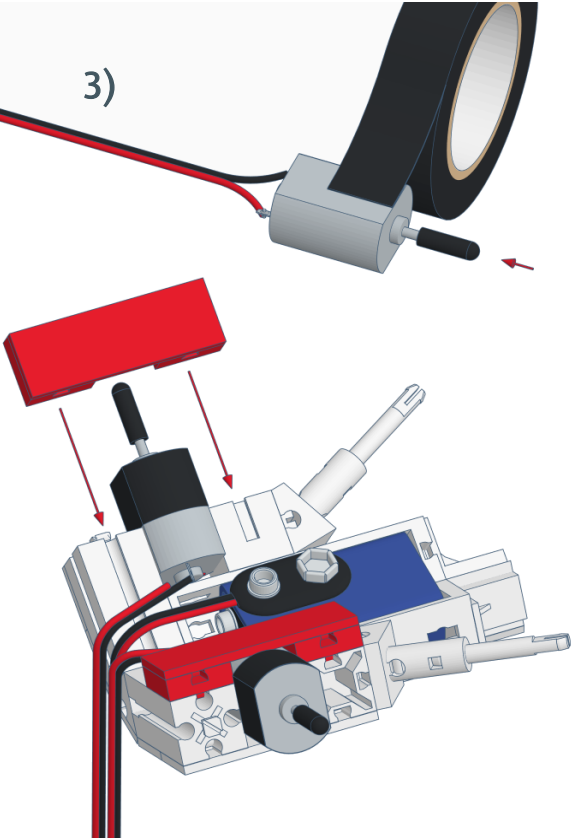

4)

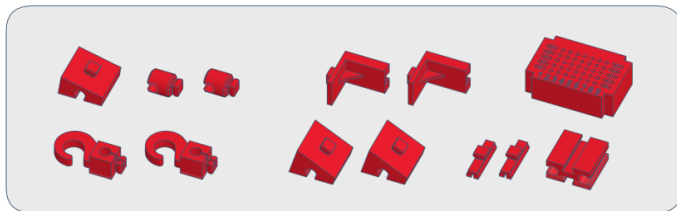
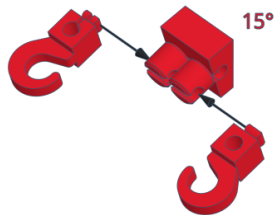

Digits to the front
1 2 3 4 5 6 7 8 9

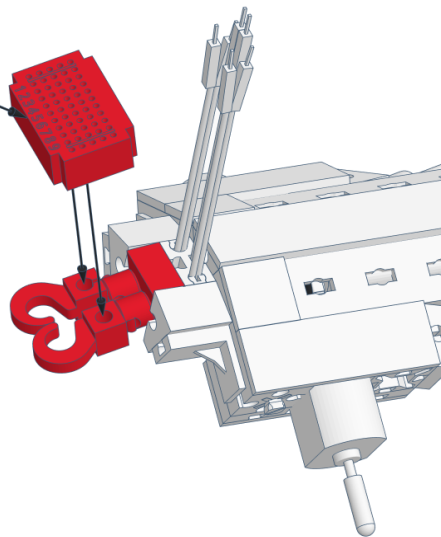
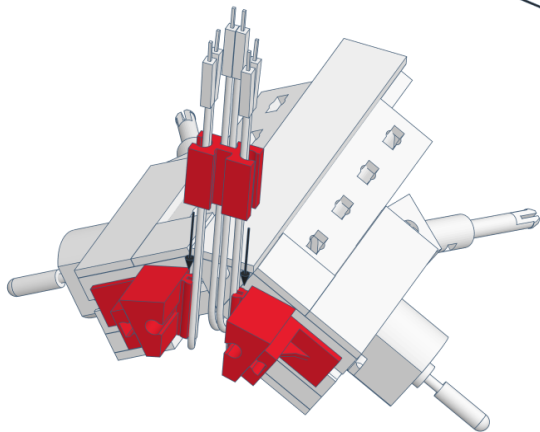

B) Circuit

1) Resistor

The resistor has four colored rings that indicate its value of $150\ \Omega$ (0hm).

Using your hands, bend the connecting wires to 90° directly next to the resistor body. Then cut them to about half their length.

Insert the resistor into the center of the breadboard in rows 3 and 7 (over the cable tie).

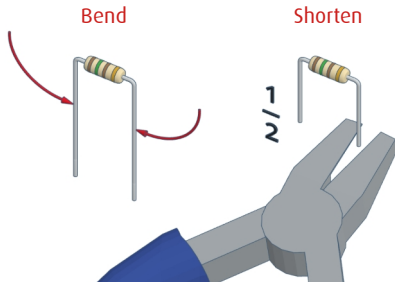

2) Transistors

varikabi uses two different transistors, which can be distinguished by their labels: BC516 or BC517

Bend the two outer legs slightly apart and then plug the transistors into the breadboard next to the resistor.

Make sure not to mix up the BC516 and BC517 transistors, and insert each one correctly oriented.

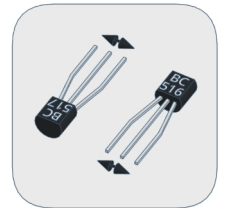
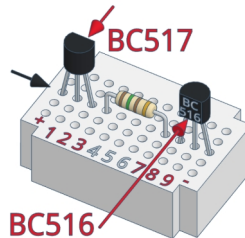

3) Sensors

Bend the connecting wires of the 3 sensors apart as shown below. Align them according to the hole spacing on the breadboard as follows:

The connections of the middle sensor should be about 2 hole spacings apart, and those of the side sensors approximately 5 hole spacings apart.

Pay attention to the correct polarity of the sensors. The + side has a shorter lead and a flat side on the housing.

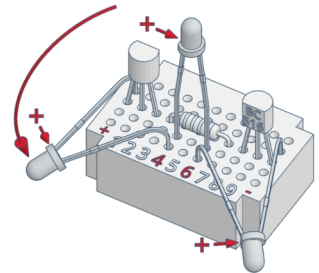
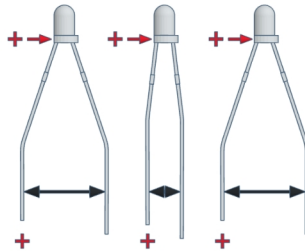
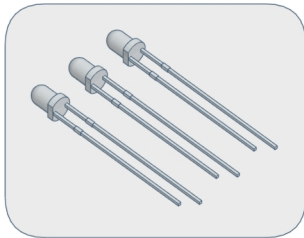

Insert the middle sensor into rows 4 and 6 directly in front of the resistor on the breadboard, ensuring the shorter lead is on the left side.

Then insert the outer sensors, correctly polarized, into rows + and 4, and 6 and -, respectively, on the breadboard. The outer connections should be inserted directly behind the respective transistor.

Finally, bend the two outer sensors downwards by hand until they are inclined at approximately a 30-degree angle to the ground.

4) Cables

Insert the motors' black connectors into the + and - rows at the very back of the breadboard. Insert the red cables into rows 2 and 8.

Ensure that the red wires are crossed!



Then, insert the blue jumper wires at the very back into rows 1 and 4, and 6 and 9, respectively.

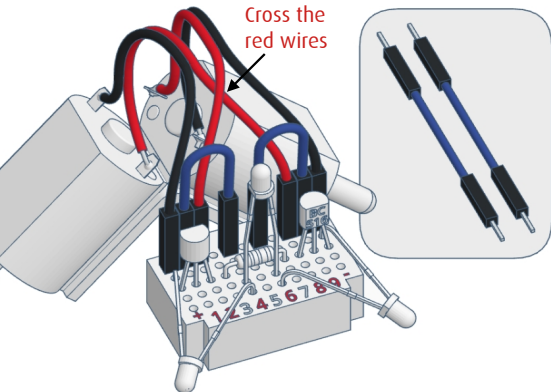

5) LEDs

Insert the two LEDs (red, blue, or green), each with the shorter leg on the right, into rows 2 and 3, and 7 and 8, next to the middle sensor.

The shorter legs and the flattenings on the housing indicate the negative connections (-) of the LEDs.



Finally, bend the LEDs near the housing by hand approximately 45° forward and downwards.

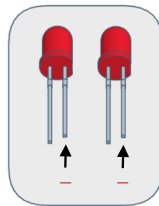

Insert the shorter leg on the right side

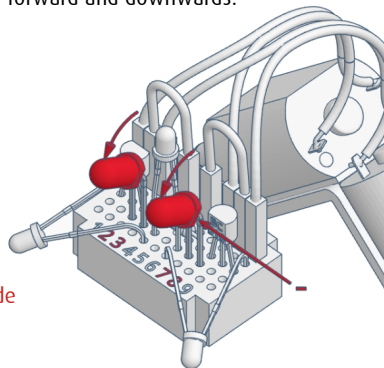

6) Power Supply

Depending on the varikabi model, you can, for example, lead the battery's two plug-in connections from below and through the gap between the motors and the battery.

Then insert the black (-) and red (+) contacts into the outermost rows on the breadboard.

Now, slide the two white rubber grommets onto the LEDs.

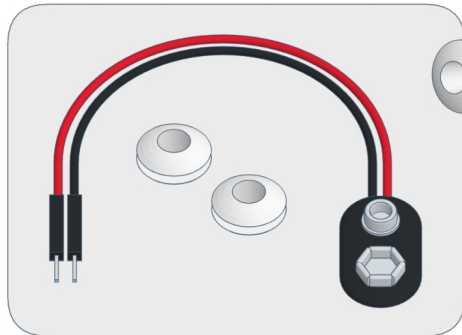

Always use the clip connector on the battery to turn varikabi on and off.

To avoid a short circuit, leave the plugs in the breadboard.

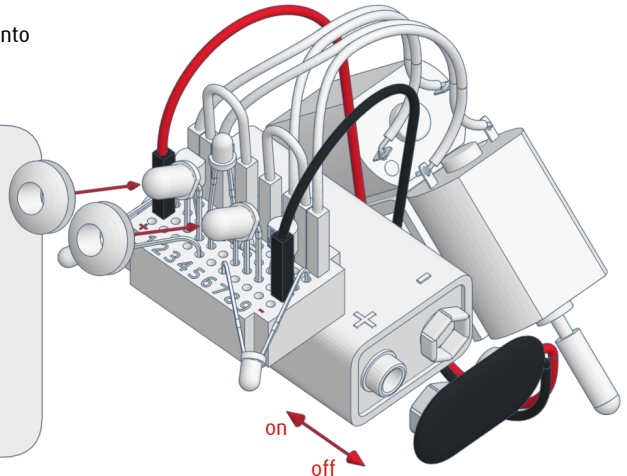

Startup Procedure

Connect the battery clip to the battery and test varikabi, preferably on a smooth and bright floor to prevent it from falling off the table.

If your circuit is constructed correctly, varikabi will move towards the light and avoid dark objects.

However, if you cover the middle sensor with your hand, varikabi will quickly move straight ahead.

varikabi compares the brightness via its three sensors. Depending on the orientation of the sensors, it detects the light conditions on the ground, ahead, or above itself.

Unlike other robots, varikabi doesn't need to emit infrared light to detect lines or objects, for example. This simplifies the circuit and reduces power consumption.

Since varikabi responds to the differences in brightness, however, it is important to pay attention to the type of lighting in the room.

Notes on Lighting

To ensure varikabi's sensors aren't blinded by the light sources, make sure varikabi is well positioned in relation to lamps and windows.

- Operate varikabi preferably under a distant light source or beneath a window on the floor.

If light comes from the sides, varikabi might follow this light or its own shadow instead of moving towards the desired goal.

- When using LEDs or fluorescent light bulbs, ensure the lighting is bright enough for varikabi to detect it.

The light from LEDs and fluorescent light bulbs has a low red component and isn't easy for varikabi's sensors to detect.

- Make sure the ground does not reflect light.

Fault Diagnosis

Problem	Possible Reasons
varikabi does not move at all.	<ul style="list-style-type: none">• The left and right sensors are incorrectly polarized.• The red cables of the motors are not crossed.• The battery cable is incorrectly inserted in the breadboard.• The battery is empty or defective.
Only one of the motors is running.	<ul style="list-style-type: none">• A transistor is connected with the wrong polarity.• The transistors BC516/BC517 are installed reversed.• Either the left or the right sensor is incorrectly polarized.• One of the motor's connections isn't plugged in correctly.
A motor runs backwards.	<ul style="list-style-type: none">• This motor is connected with the wrong polarity.
varikabi only drives straight ahead.	<ul style="list-style-type: none">• The center sensor is connected incorrectly.
The two LEDs don't light up.	<ul style="list-style-type: none">• One or both LEDs are inserted with the wrong polarity.
varikabi gets stuck on the ground.	<ul style="list-style-type: none">• varikabi is placed lopsided on the cable ties.• The surface is too uneven for varikabi.

If none of these causes apply to your problem, check carefully that all components are installed as described in the construction plan.

If you need help, please contact us with a detailed error description and a photo or video of your varikabi robot: [**info@variobot.com**](mailto:info@variobot.com)

C) Circuit Variants

Thanks to varikabi's variable control circuit, four fundamental behaviors can be defined:

- Light follower / Shadow follower
- Acceleration mode / Brake mode

Since you can also change the alignment of the sensors, there are ultimately 12 surprisingly versatile functions possible. varikabi reacts not only to light and shadows but also to markings and various objects.

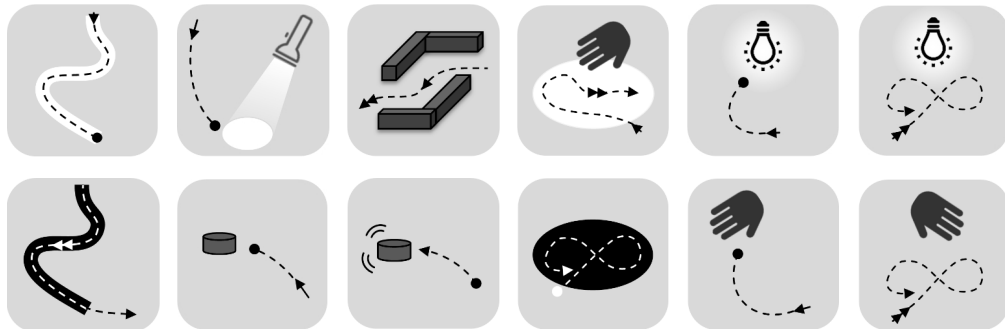

- varikabi stands still.
- varikabi moves slowly.
- varikabi moves quickly.

On the following pages, you learn the following:

- how the 4 behaviors differ
- all about the 12 functions
- how to adjust the sensors

Light follower or Shadow follower

There are two different ways to connect the motors (M_2, M_1) to the transistors (T_2, T_1), which automatically connects them to the sensors.

How the motor cables are plugged in defines whether varikabi will follow the light or shadows (dark objects).

Light follower

For a light follower, the red cables should be plugged in on the inside. If, more light falls on the left sensor, then the right motor will run faster.

Shadow follower

For a shadow follower, the black cables should be on the inside. If, for example, more light falls on the left sensor, then the left motor will run faster.

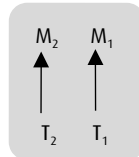
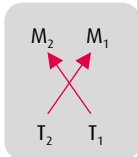
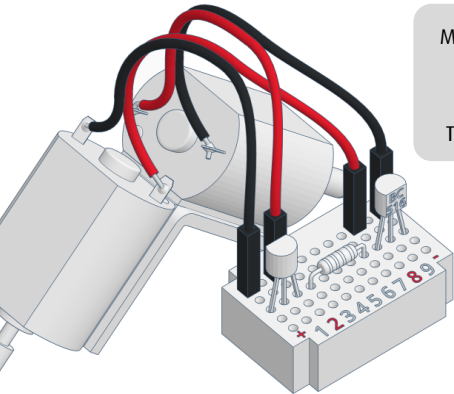

The red cables should always be crossed!

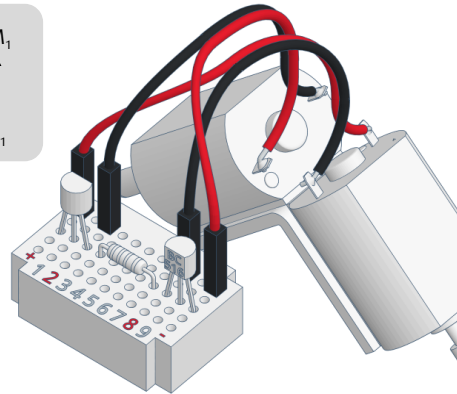

Braking or Accelerating

Using the blue cables, there are two different ways to connect the transistors (T_2 , T_1) to the three sensors (S_2 , S_3 , S_1).

Cross the cables (brake mode) or keep them side by side (acceleration mode).

varikabi's LEDs only light up in brake mode if it's standing still and in acceleration mode if it's running at the highest possible speed.

Depending on the mode, you have to plug in the LEDs differently polarized.

Brake mode

If less light falls on the middle sensor, both motors will slow down.

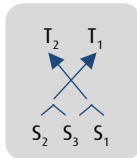
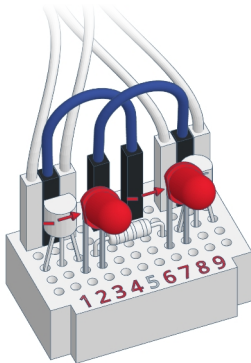

Acceleration mode

If less light falls on the middle sensor, both motors will speed up.

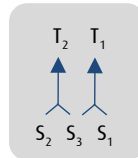
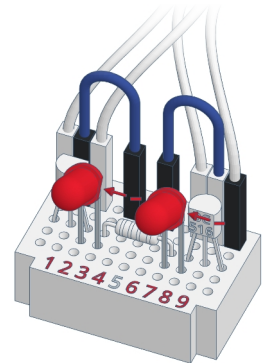

Both LEDs should be plugged in with the same polarity!

1) Following Light Lines

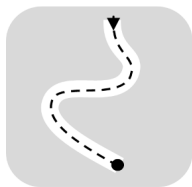

varikabi moves along bright lines (e.g. over white paper strips on a dark background).

varikabi stops at the end of the line.

Circuit:

- Light follower
- Brake mode

Sensors:

Point the middle one approximately 60° downward towards the ground and the outer ones about 45°.

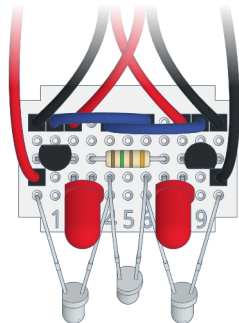

Adjust the distance between the side sensors to the width of the line. Experiment with the tilt of the sensors so that varikabi comes to a stop at the end of the line.

2) Following Dark Lines



varikabi moves along dark lines (e.g., on black electrical tape).

varikabi accelerates on straight lines and brakes in sharp curves.

Circuit:

- Shadow follower
- Acceleration mode

Sensors:

Align all 3 sensors parallel to the front and about 45° downward towards the ground.

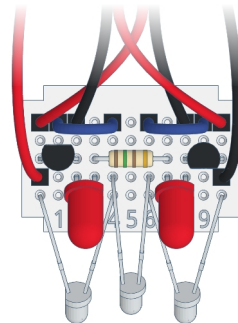

Experiment with the distance of the side sensors, as well as with the tilt of the middle sensor, to adjust the speed control as well as possible.

3) Tracking Light



varikabi follows a light beam on the ground (flashlight) and stops just outside the light.

varikabi also stops when a shadow is cast over it.

Circuit:

- Light follower
- Brake mode

Sensors:

Point the middle one vertically upwards and the outer ones approx. 45° downward towards the ground.

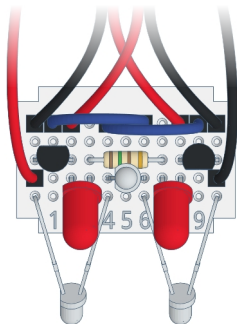

The lighting should not be too strong for this function, so that varikabi can recognize the light beam well. Experiment with the distance and the tilt of the side sensors.

4) Tracking Objects

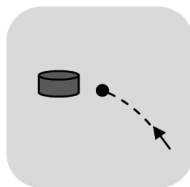

varikabi moves towards dark objects directly in front of it and stops in front of them.

varikabi follows objects that move.

Circuit:

- Shadow follower
- Brake mode

Sensors:

Point all 3 downwards: the middle one to about 45° and the outer ones to about 30°.

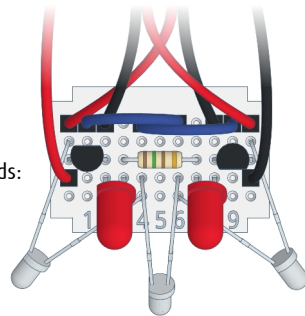

Adjust the distance of the side sensors to the size of the object. Experiment with the tilt of the sensors so that both following and stopping work well.

5) Avoiding Obstacles

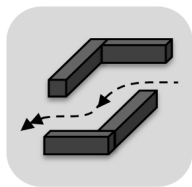

varikabi avoids dark obstacles and can accelerate when it has a clear path.

It can navigate an obstacle course.

Circuit:

- Light follower
- Acceleration mode

Sensors:

Point the middle one approx. 30° upwards and the side ones 30° downwards.

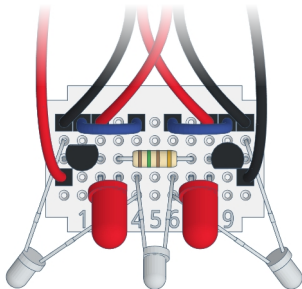

The more you point the side sensors downwards, the closer varikabi will approach obstacles. The middle sensor must be directed slightly above the obstacles.

6) Pushing Objects

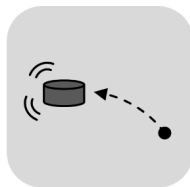

As long as nothing is in sight, varikabi stands still.

If a small dark object is directly in front of varikabi, it will push the object ahead of itself.

Circuit:

- Shadow follower
- Brake mode

Sensors:

Point the middle one approx. 30° upwards and the outer ones 45° downwards towards the ground.

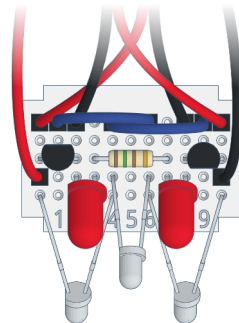

Adjust the distance of the side sensors to the size of the object to be followed. Set the tilt angle of the middle sensor so that it is directed only slightly above the object.

7) Avoiding Dark Areas



varikabi stays on bright surfaces and avoids dark obstacles.

When a shadow is cast over it, it accelerates and flees.

Circuit:

- Light follower
- Acceleration mode

Sensors:

Point the middle one vertically upwards and the side sensors approx. 30° downwards.

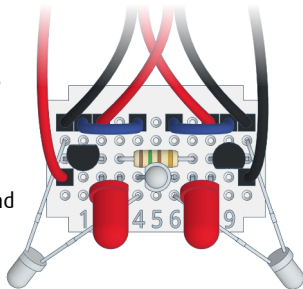

The bright area can be, for example, your room floor or a well-lit bright table. If you hold your hand over varikabi, it will drive straight ahead without paying attention to its surroundings.

8) Avoiding Bright Areas

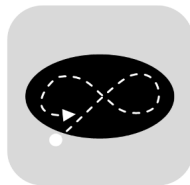

varikabi rides around and stays on dark surfaces.

It turns away from bright areas or stops at the edge of them.

Circuit:

- Shadow follower
- Brake mode

Sensors:

Point the middle one approximately 30° upwards and the side ones about 30° downwards.

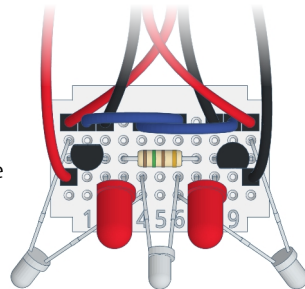

Adjust the tilt of the side sensors so that varikabi always turns in time at the edge. Adjust the tilt angle of the middle sensor so that varikabi stops at bright surfaces.

9) Following Light



varikabi moves toward light from above it and stops underneath.

It turns away from shadows to move back into the light.

Circuit:

- Light follower
- Brake mode

Sensors:

Point the side ones approximately 30° backwards and the middle one about 45° forwards.

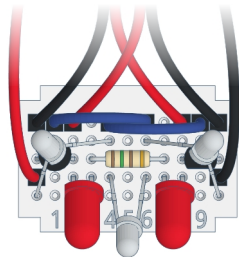

The more you point the middle sensor upwards, the closer varikabi will come the light above it. If you hold your hand between the light and varikabi, it tries to move back into the light.

10) Following Shadows



varikabi avoids light and moves towards a shadow over it (e.g., a hand).

It stops in the shadow or follows it if the shadow moves.

Circuit:

- Shadow follower
- Brake mode

Sensors:

Point the middle one vertically upwards and the side ones approx. 60° upwards.

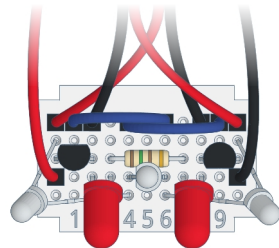

First, hold your hand over varikabi to stop it. Then, move your hand slowly forward or to the side, so that varikabi can follow it. Make sure you don't have dark sleeves.

11) Remaining in the Light



varikabi seeks a light and quickly moves towards it.

Then, it constantly turns to stay in the light and accelerates when a shadow is cast over it.

Circuit:

- Light follower
- Acceleration mode

Sensors:

Point the middle one vertically upwards and the side ones approx. 30° forwards.

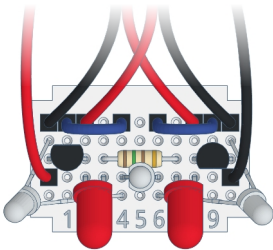

If you place varikabi some distance away from the light, it quickly moves towards the light. For varikabi to continue turning back towards the light, the tilt of the sensors has to be well adjusted.

12) Remaining in a Shadow



varikabi moves away from light and accelerates when a shadow is over it.

Then, varikabi constantly tries to turn to stay in the shadow.

Circuit:

- Shadow follower
- Acceleration mode

Sensors:

Point the side ones approximately 45° backwards and the middle one vertically upwards.

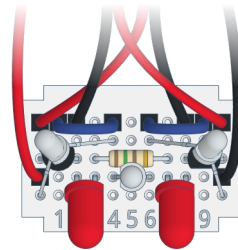

For this function, it is especially important to use very uniform lighting. In order for varikabi to turn around repeatedly, the tilt of the sensors must be very well adjusted.

D) Operating Principle

1) Resistor

A resistor limits the flow of current in a circuit and releases energy in the form of heat.

It is used for voltage division, controlling current strengths, and as protection for sensitive components.

Resistors often have 4 or 5 colored rings printed on them, which are referred to as color codes.

In 4-band resistors, the first two rings represent the value, the third ring is the multiplier, and the fourth ring is the tolerance.



The 150 Ω (Ohm) resistor in the varikabi kit limits the current flowing through the two LEDs. The first brown ring stands for "1", the green for "5", the second brown one for "times 10" and the gold ring for an accuracy of $\pm 5\%$.

The schematic symbol for a resistor:

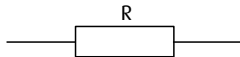

2) LEDs

Light Emitting Diodes (LEDs) are components that convert electrical energy into light by conducting electrons through a semiconductor layer. They are known for their energy efficiency, longevity, and compact size, making them a popular alternative to incandescent and fluorescent light bulbs.

Unlike incandescent bulbs, however, LEDs need to be correctly polarized to light up. The shorter leg and the flat side on the casing mark the negative terminal (cathode).



Additionally, LEDs require a current-limiting resistor connected in series with the LED to regulate the current flowing through it.

The schematic symbol for an LED:

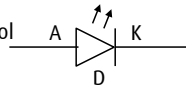

3) Transistors

A transistor is a fundamental electronic amplifier with three terminals: Base (B), Emitter (E), and Collector (C).

The amplification factor β is defined as the ratio between the collector current I_C at the output and the base current I_B at the input.

To control varikabi's motors using sensor signals, so-called Darlington transistors are used. These have a particularly high current amplification of $\beta = 30000$.

A motor and two LEDs together require a current of about 30 mA (milliamperes). For this, a base current of only 1 μ A (microampere) is sufficient.

$$30 \text{ mA} / 30000 = 0.001 \text{ mA} = 1 \mu\text{A}$$

The configuration of pins may vary with different manufacturers.

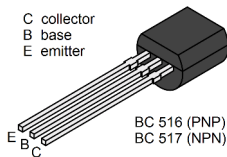

With a voltage between the base and emitter of about $U_{BE} = 0.7 \text{ V}$ ($\text{V} = \text{Volt}$), a transistor reduces the resistance between collector and emitter and switches through.

Darlington transistors have two transistors connected in series. Therefore, they require approximately $U_{BE} = 1.4 \text{ V}$ to switch through.

In order for varikabi's motors to respond in opposite directions to the left and right sensor signals, complementary transistors are used. NPN transistors (T_2) require a positive voltage U_{BE} and PNP transistors (T_1) require a negative voltage U_{BE} to switch through.

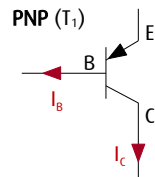
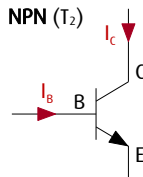

4) Collector Configuration

There are three types of transistor configurations: common base, common emitter, and common collector. varikabi uses the **common collector configuration**. It's called common collector (CC), because it's connected to a constant voltage source, in this case a battery. The voltage amplification is less than 1, but the current amplification is very high.

Because the emitter voltage U_E follows the base voltage U_B up to the difference of U_{BE} , this configuration is also called an **emitter follower**.

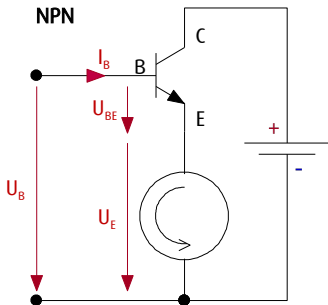

The red arrows indicate the voltages.

It can be seen that the voltage at the motor (U_E) is smaller than the base voltage (U_B) by the base-emitter voltage (U_{BE}).

$$U_E = U_B - U_{BE} = U_B - 1.4 \text{ V}$$

The illustration on the bottom left shows a simple collector configuration with an NPN transistor, a battery, and a motor. On the bottom right is the corresponding circuit with a PNP transistor.

In each case, the current flows in the direction of the transistor's black arrow, from positive to negative.

With the control voltage U_B and a very small current I_B , the voltage U_E and with that, the speed of the motor can be controlled.

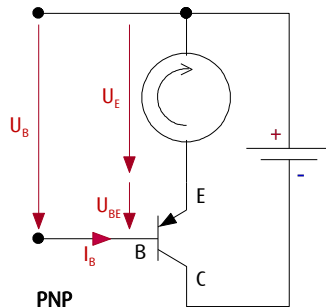

5) Phototransistors

varikabi's sensors are so-called phototransistors (FT). Just think of them as variable resistors whose resistance value decreases with increasing brightness.

However, their structure is more like a transistor. Instead of a base connection, a phototransistor has a light-sensitive area.

The intensity of the light determines the conductivity between collector (C) and emitter (E).

In the illustration, it can be seen that varikabi's phototransistors FT₂, FT₃, and FT₁ are all interconnected. Such a **series connection** of (variable) resistors forms a so-called **voltage divider**. This divider splits the supply voltage of the 9 V battery depending on the lighting conditions of the respective phototransistors.

The variable voltages U_1 and U_2 control (via the transistors) the speeds of varikabi's motors.

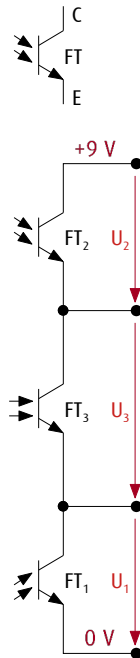

Two examples:

- If all three sensors are lit up equally, regardless of the overall brightness, the supply voltage divides evenly:

$$U_2 = U_3 = U_1 = 3 \text{ V}$$

- If the middle sensor FT₃ is lit up four times brighter than FT₂ and FT₁, a voltage four times smaller would drop across FT₃, and the supply voltage would divide as follows:

$$U_2 = 4 \text{ V}, U_3 = 1 \text{ V}, U_1 = 4 \text{ V}$$

U_1 , U_2 , and U_3 are inversely proportional to their respective lighting conditions.

6) Acceleration mode

The slanted blue connections between the sensors and the transistors represent the cable bridges. When less light falls on the middle sensor FT_3 , both transistors switch through more, and the motors run faster.

Light follower

If, for example, more light falls on the sensor FT_2 , the voltage at both transistor inputs increases. Then, motor M_1 speeds up and M_2 slows down.

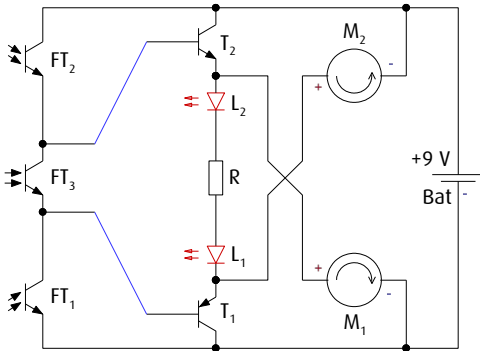

The two LEDs are arranged in series with the resistor between the transistors. Therefore, they can only light up together. In acceleration mode, they light up whenever both transistors are fully switched through.

Shadow follower

In this case, the motors and transistors are connected differently. If more light falls on sensor FT_2 , motor M_2 speeds up and M_1 slows down.

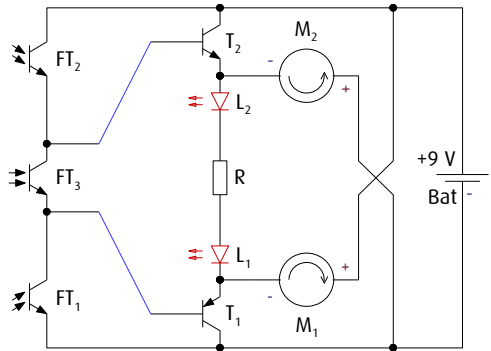

7) Brake mode

The sensors and transistors are now connected in a crosswise manner. Therefore, if less light falls on the middle sensor FT_3 , both transistors switch through less and the motors slow down or stop completely.

Light follower

Despite the crossed sensor signals, the voltage at both transistor inputs will again increase when more light falls on sensor FT_2 .

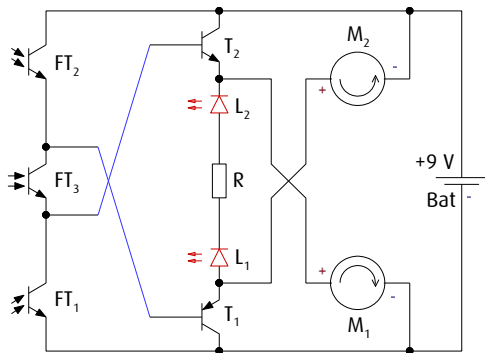

In brake mode, the LEDs are now reverse-poled between the transistors. However, they can still light up. When both transistors are blocked, the LEDs are powered by the stationary motors.

Shadow follower

Once again, the motors and transistors are connected differently. If more light falls on one of the sensors FT_1 or FT_2 , varikabi turns away from it.

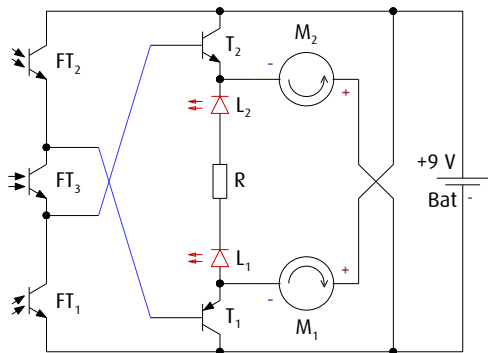

E) Extensions

1) Supplementary Set

Make exciting line-tracking courses, boost varikabi's speed or give your robots a splash of color!

1) Line-Tracking Course

Quickly create extensive tracks with this flexible, black adhesive tape. Sharp turns, dead ends that lead to ramps, you name it, you can make it!

2) High-Speed Wheels

Win every race with varikabi! The two rubber ball wheels make your mini-robot zip along twice as fast.

3) Get Creative

These multicolored cable ties are not just for repairs! Use them to build additional varikabi models or invent your own unique creations.



2) Infrared-Set

With this extension set, you can build your own infrared remote control for your varikabi robot.

You can also equip it with infrared light, allowing it to avoid bright obstacles, follow bright objects, or be followed by other varikabis.

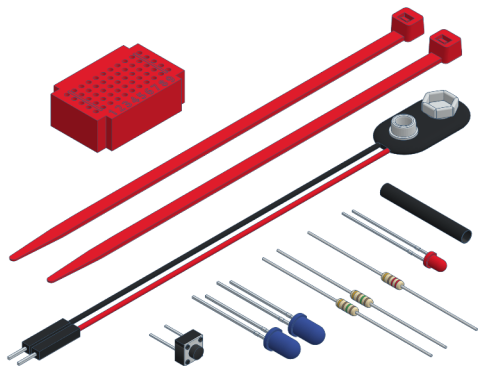

There are three basic ways to use infrared LEDs. The setup for the different applications is detailed in a separate manual.

1) Infrared Flashlight

With an additional battery, you can build an infrared remote control for your robot and navigate it through your home at the push of a button.

2) Infrared Reflective Light Barrier

If you mount the infrared LEDs instead of the normal LEDs on varikabi, the infrared light reflected off objects can be detected by the sensors and used for obstacle detection.

3) varikabis in Interaction

Use the infrared LEDs to have another robot follow or avoid the infrared light of your varikabi.

3) Capacitor-Set

With this expansion set, you give your little robot a kind of short-term memory, making varikabi's behavior even more versatile.

In addition, you can replace your colored LEDs with the special red/blue LEDs. These light up in both directions, so they never need to be reverse-poled again.

The setup of the various circuits is described in detail in a separate manual.

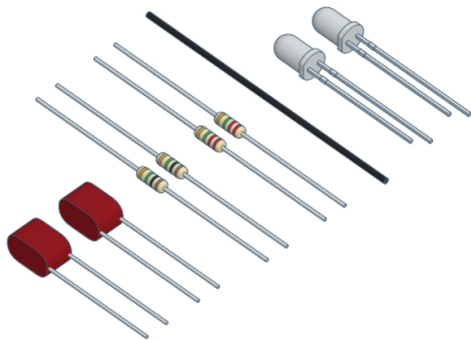

Discover four exciting ways you can use the two capacitors and additional resistors for your varikabi:

1) Take It Easy

With the built-in capacitor, it takes a while for varikabi to decide to stop and start moving again.

2) A Drunken Robot

Because varikabi reacts slowly, it now moves in a serpentine pattern.

3) Skittish and Trusting

This circuit combines the brake and acceleration modes with a time delay, and the LEDs light up blue or red respectively.

4) A Wobbling Dachshund

The left and right motors are alternately switched on and off.